



Frame Guide

Comprehensive guide of accessories and frames for the PR series and VR embroidery machines.



Frame Holder A Accessories

Note:
 PR frame holder A
 VR frame holder a
 Compatibility varies by model and range, check the charts on pages 14-17 for frames that work with specific models.

PRH60
 60 x 40mm Standard Embroidery Frame



60 x 40 mm embroidery hoop for a variety of applications.

PRH100
 100 x 100mm Standard Embroidery Frame



100 x 100 mm embroidery hoop for a variety of applications.

PRH180
 180 x 130mm Standard Embroidery Frame



180 x 130 mm embroidery hoop for a variety of applications.

PRH300
 300 x 200mm Standard Embroidery Frame



300 x 200 mm embroidery hoop for a variety of applications.

PRF300
 300 x 200mm Embroidery Flat Frame



The unique design of this flat frame prevents fabric bunching when embroidering any bulky material, even on the back of jackets.

PRPH360
 360 x 200mm Standard Embroidery Frame



360 x 200 mm embroidery hoop for a variety of applications.

VRTF200
 200 x 200mm Tubular Frame



200 x 200 mm embroidery hoop for a variety of applications.

VRFF200
 200 x 200mm Flat Frame



Embroider jackets and other thicker materials with this flat frame. Great for quilting.

Frame Holder B Accessories

Note:
 PR frame holder B
 VR frame holder b
 Compatibility varies by model and range, check the charts on pages 14-17 for frames that work with specific models.

PRHSL200
 70 x 200 Sleeve Frame



The 70 x 200mm frame is the perfect size for embroidering difficult to access areas such as jacket sleeves, pant legs, kids' T-shirts and baby rompers.

The sleeve frame features a unique 'wing' design in which the adjustable screw is placed at one corner, allowing the frame to hold your fabric more securely.

PRPQF200
 200 x 200mm Square Quilt Frame



Use this frame for quilting, children's shirts and jacket backs, totes and backpacks.

For heavy objects the optional table is recommended.

PRPJF360
 360 x 360mm Jumbo Embroidery Frame



Jumbo Embroidery Frame 360 x 360mm

This is the largest frame available for a multi-needle embroidery machine.

Large designs require PE-Design 10 or above.

PRPBF1
 300 x 100mm Border Frame



Re-hoop your fabric without removing the frame. Just release the latches, slide the fabric to the next embroidery position, and relock.

VRBF180
 180 x 100mm Border Frame



Re-hoop your fabric without removing the frame. Just release the latches, slide the fabric to the next embroidery position, and relock.

Included are the 180 x 100 mm border frame and a USB flash drive containing 50 border embroidery designs.

Frame Holder C Accessories

Note:
 PR frame holder C
 VR frame holder c
 Compatibility varies by model and range, check the charts on pages 14-17 for frames that work with specific models.

PRPRFK1

Round Frame Set
for PR Series



Round frame set perfect for embroidery on shirts and other designs that needs more stability.

3 round frames - 100, 130 and 160mm included

Includes Arm "C" Embroidery Frame Holder, which must be used with all frames in this kit

VRRFK1

Round Frame Set
for VR



Round frame set perfect for embroidery on shirts and other designs that needs more stability.

3 round frames - 100, 130 and 160mm included

Includes Arm "c" Embroidery Frame Holder, which must be used with all frames in this kit

PRPARMC

Arm-C for Brother
PR-Series Round Frames



Arm C is for use with the round frames to attach them to the machine.

Only the arm is included

For the VR - Order Arm c part code XG1552101

PRPRF100

100mm Round Frame



Additional round embroidery frame for PR-Series and VR round frame sets, PRPRFK1 / VRRFK1

PRPRF130

130mm Round Frame



Additional round embroidery frame for PR-Series and VR round frame sets, PRPRFK1 / VRRFK1

PRPRF160

160mm Round Frame



Additional round embroidery frame for PR-Series and VR round frame sets, PRPRFK1 / VRRFK1

Frame Holder D Accessories

Note:
 PR frame holder D
 VR frame holder d
 Compatibility varies by model and range, check the charts on pages 14-17 for frames that work with specific models.

PRCLP45B

45 x 24mm Clamp Frame and Arm-D



The arm size is designed small enough to fit most shoe sides and still has an adequate stitch field for logos, flags, initials, names, numbers etc. The frame has an adhering non-slip surface to hold leather and nylon secure during embroidery. It works well with backpacks, gloves, pockets, hats, cuffs and more!

Includes mounting arm "D" and forward-facing clamp frame 45 x 24mm

PRCLP45LR

Clamp frame 45 x 24mm left and right

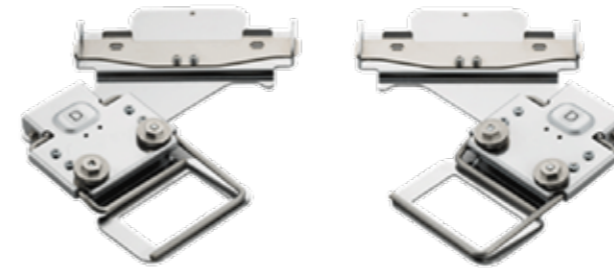

Ideal to embroider on shoes, inner pockets, collars, cuffs, belts and other smaller areas.

The left and right clamp frames give you more opportunity to embroider onto difficult corners and hard to frame items.

45 degree left and right

Arm "D" not included

PRCLP100B

100 x 100mm
Clamp Frame Set

VRCLP100B

100 x 100mm
Clamp Frame Set



The click and snap design allows you to hoop your project easily in seconds – so much easier than using standard, two-piece frames! The inside of one side of the frame has a smooth, rubber grip, and the other side has a textured fabric grip – the combination of these two surfaces against your fabric helps keep your project in place, without damaging the fibres

PRCLP100B includes arm D for PR series

VRCLP100B includes arm d for VR

VRCLP45B

45 x 24mm Clamp Frame
and Arm-d

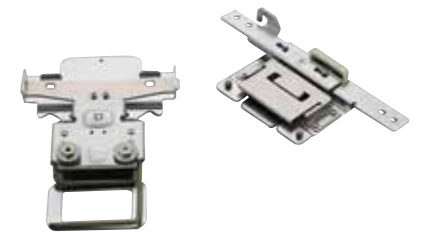

The arm size is designed small enough to fit down into most shoe sides and still have an adequate stitch field for logos, flags, initials, names, numbers etc. The frame has a non-slip surface to hold leather and nylon secure during embroidery. It works well with backpacks, gloves, pockets, hats, cuffs and more!

Includes mounting arm "d" and forward facing clamp frame 45 x 24mm

VR only

Frame Holder E Accessories

Note:
 PR frame holder E
 VR frame holder e
 Compatibility varies by model and range, check the charts on pages 14-17 for frames that work with specific models.

PRSFK1
 Compact frame kit



This kit includes four mini frames, ranging in size from 44 x 38mm to 70 x 41mm. Allows you to easily add embroidery to smaller areas.

Includes 4 frames: 44 x 38mm, 50 x 50mm, 33 x 75mm, 70 x 41mm.

Includes Arm "E" Embroidery Frame Holder, which must be used with all frames in this kit.

PRMFA50
 50 x 50mm magnetic frame and arm



This frame allows you to embroider fabric without leaving hooping marks, especially for fabric prone to that.

Arm E included. If you already have this arm, please choose PRMF50 magnetic frame only.

PRMF50
 50 x 50mm magnetic frame



Magnetic frame only, for use with Arm E on PR series or Arm e on VR.

Arm E is not included in this accessory. If you need Arm E, please choose PRMFA50.

Arm e is include with the VR.

VRSF70
 70 x 41mm Compact S Frame



70 x 41mm S Frame ideal for adding embroidery to pockets and sleeves.

Requires the embroidery frame holder -

Arm "E" for PR-Series
 Arm "e" for VR

VRSF50
 50 x 50mm Compact S Frame



50 x 50mm S Frame ideal for adding embroidery to pockets and sleeves

Requires the embroidery frame holder -

Arm "E" for PR-Series
 Arm "e" for VR

VRSF44
 44 x 38mm Compact S Frame



44 x 38mm S Frame is ideal for adding embroidery to pockets and sleeves.

Requires the embroidery frame holder -

Arm "E" for PR-Series
 Arm "e" for VR

VRSFV
 33 x 75mm Compact S Frame



33 x 75mm S Frame ideal for adding embroidery to pockets and sleeves.

Requires the embroidery frame holder -

Arm "E" for PR-Series
 Arm "e" for VR

PRMFJ1
 Free-Arm Mounting Jig for Magnetic or Compact Frame



When embroidering cylindrical items, this mounting jig can be used to secure the magnetic frame or compact frame in order to hoop the fabric easily and securely.

Compatible for hoops which use arm "E" or "e"

Table - Free Motion - Stands

PRTT1
 Tubular Frame Table



Embroider easily on sleeves, trousers, and other tubular items. Serves as extra support for big fabrics. Easily attach and remove with no space between machine and table.

Easy-to-attach to the machine (one-action)

Table size is adjustable by spring allowing for smooth expandable movement of the frame and stable sewing

Foldable free arm makes storage easy

Can be used with all PR and VR models

VRPRNSTD
 Stand for Brother PR-Series and VR



Our stand, designed exclusively for the PR and VR Series, now has a wider table area with rounded edges and extra storage for all your large frames, like the Cap Frame and Cylinder Frame.

Legs can be adjusted by 2 inch increments

Locking wheels allow for easy moving and transportation

Rubber and locks secure your machine and resist vibration while in use

Added space for the cap frame jig which is ideal for prepping hats for embroidery

Large shelf provides storage for accessories, instruction books and small supplies

VRFMK1
 K1 Free motion embroidery kit



Convert the VR into a free motion embroidery machine for quilting and free motion sewing.

PRWT1
 Wide Table for Brother PR-Series



Durable surface, great for supporting large or heavy items like quilting squares, towels, blankets, jackets and rugs

Scan Frame

PRSCANFKIT1 Scan Frame Kit



With the PR Scan Kit there are so many ways to create a custom personal work of art – and a really fun way to create embroidery!

My Design Center integrates with our Camera Scanning Technology to offer new design capabilities at your fingertips, all without a PC. Draw or doodle directly on the LCD display, and watch it spring to life in the large drawing area. Or, use the scanning frame to scan line art, handwriting or printed clip art and have it transformed into embroidery data. Easily add stippling or fill patterns to your embroidery designs and quilt blocks.

DRAW DIRECTLY ON THE SCREEN

Use the included stylus to draw directly to the LCD screen.

SCANNING FRAME

With the Scanning frame you can scan drawings and clip art directly into My Design Center.

OUTLINE RECOGNITION FOR STIPPLE AND FILL PATTERNS

Accurately stipple anywhere on any project. Add stippling or fill to any embroidery design, whether built-in or imported. Import your saved outline, choose from 10 new built-in decorative fill patterns or stipple stitch and the machine does the rest. Plus, with the enhanced Preview mode, see both the scanned design and selected stippling or fill pattern.

Compatible INSIDE & OUTSIDE AUTO STIPPLE AND FILL PATTERN

Use the built-in library of shapes to add interesting detail to any project. You can even combine shapes and apply inside or outside stippling. And now you can choose decorative fill patterns with separate stitch settings to create unique designs. Includes 60 closed shapes, 30 open shapes, and 5 line options - satin stitch, single stitch, triple stitch, candlewick and diamond.

Compatible with PR1050 and *PR1055X.

* Included with the PR1055X

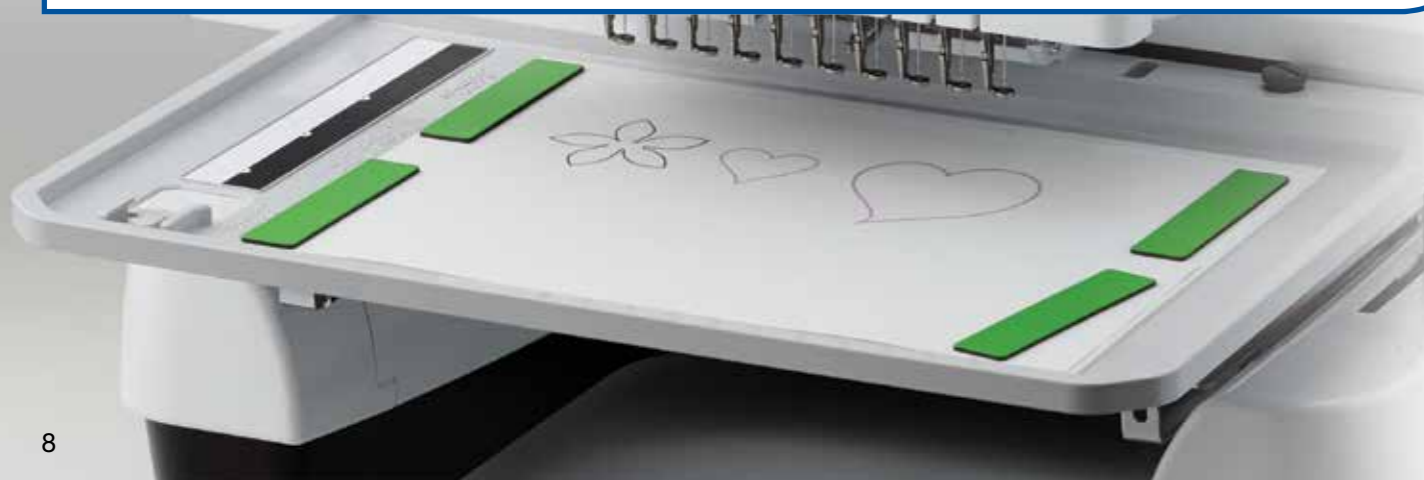

Cap Frames

PRPCF1

Wide Cap Frame and Driver Set. Embroidery area 360mm x 60mm



The Brother PRPCF1 provides expanded embroidery area, allowing you to stitch caps virtually ear-to-ear.

PRCF3

Cap Frame and Driver Set. Embroidery area 130mm x 60mm



The Advanced Cap Frame Set gives you a generous area for cap embroidery.

PRCF5

Flat brim cap frame set. Embroidery area 130mm x 60mm



Patent-Pending Industry-First 'Scratch-Free' Flat Brim Cap Frame. Embroider more types of hats than before with the easy-to-use 'scratch-free' cap frame.

You can stitch an industry leading 35% closer to the brim (6-10mm), depending on the cap.

PRPCFH4

Wide Cap Frame (frame only)



Extra cap frame for PRCF1 set

PRCFH3

Cap Frame (frame only)



Extra cap frame for PRCF3 set

PRCFH5

Flat brim cap frame (frame only)



Extra cap frame for PRCF5 set



Cyclinder Frame

PRCL1

Cylinder Frame and Driver Set



The Brother PRCL1 allows you to stitch fashion and logo embroidery on long narrow pant legs, sleeves and other locations.

PRCLH1

Cylinder Frame PRCLH1 (frame only)



The Brother PRCLH1 Cylinder Frame is perfect for setting up a second project while the first is being embroidered.

Extra Cylinder Frame for PRCL1.

Magnetic Frames

PRMS360 Magnetic Sash Frame



Patent-Pending Brother-Exclusive Hoopnetic Magnetic Frame. Hoop and embroider thick materials with ease. Avoid fabric shifting and the need to rehoop the fabric when connecting designs or embroidering large areas. Just slide the fabric on the frame for the next area to be embroidered.

PR10 needle = 360 x 200 mm
PR6 needle = 300 x 200 mm
The same frame is used for both series
Only the max embroidery area changes

PRVMFLKIT

PR versatile magnetic frame kit
130 x 180 mm (5 x 7")



PRVMFMKIT

PR versatile magnetic frame kit
100 x 100 mm (4 x 4")



Boost productivity with Brother's easy-to-use Magnetic Frame Kit. No more fiddling with catches and levers, just hoop any material up to 2 mm and go!

The magnetic frame set contains the frame and arm F for attaching to your PR.

Perfect for beginners! No catches, no levers, just place the magnets and embroider.

Embroider materials up to 2 mm thick.

Reduces scratching and hoop burn damage to your hooped materials.

Use with difficult to hoop and tubular items that cannot be hooped in traditional Clamp M hoops – tote bags, small shirts, embroidery blanks and more!

Now you can stitch on the mid and bottom parts of tote bags.

Can be used without removing the base embroidery frame from the machine.

Scale marks every 10 mm for easy position reference.



Magnetic Frames

PRVMFL

PR versatile magnetic frame
130 x 180 mm (5 x 7") (frame only)



Extra frame for PRVMFLKIT

PRVMFM

Versatile magnetic frame only
100 x 100 mm (4 x 4")



Extra frame for PRVMFMKIT

Compatibility

| | PRVMFM Kit Versatile Magnetic Frame M Kit | PRVMFL Kit Versatile Magnetic Frame L Kit | PRVMFM Versatile Magnetic Frame M Single | PRVMFL Versatile Magnetic Frame L Single |
|-----------------------|---|---|--|--|
| | | | | |
| Arm type | F | | | |
| Emb area (mm/inch) | 100 x 100mm 4 x 4" | 130 x 180mm 5 x 7" | 100 x 100mm 4 x 4" | 130 x 180mm 5 x 7" |
| Compatibility | PR10: PR1055X/PR1050X/PR1000e/PR1000 PR6: PR680W/PR670E/PR655 | | | |
| Holding system | Magnets | | | |
| Feature | <ul style="list-style-type: none"> • Can embroider tubular items • Can easily attach/detach the magnets without any tools • Can be operated without removing the frame from the machine • Greater versatility than Clamp M frame allows this frame to embroider previously hard to reach places such as the lower part of tote bags • Can embroider fabrics up to 2mm thick • Two different sizes available • There are scale marks every 10mm for easy position reference | | | |



PR and VR Accessories

PR Frame holders are always a capital letter A,B,C,D,E,F. VR Frame holders are always a lower case letter a,b,c,d,e

| Accessory Name | Frame Holder | Frame Size (mm) | Order Code | PR1055 | PR1050X | PR1000 | PR680 | PR670E | PR655 | PR650/E | PR620 | PR600II | PR600 | VR |
|---|--------------|-------------------------------|------------|--------|---------|--------|-------|--------|-------|---------|-------|---------|-------|----|
| Standard Embroidery Frame | A/a | 60 X 40 | PRH60 | ✓ | ✓ | ✓ | ✓ | ✓ | ✓ | ✓ | ✓ | ✓ | ✓ | ✓ |
| Standard Embroidery Frame | A/a | 100 X 100 | PRH100 | ✓ | ✓ | ✓ | ✓ | ✓ | ✓ | ✓ | ✓ | ✓ | ✓ | ✓ |
| Standard Embroidery Frame | A/a | 180 x 130 | PRH180 | ✓ | ✓ | ✓ | ✓ | ✓ | ✓ | ✓ | ✓ | ✓ | ✓ | ✓ |
| Embroidery Frame (Extra Large) | a | 200 X 200 | VRTF200 | x | x | x | x | x | x | x | x | x | x | ✓ |
| Square Quilt Frame | a | 200 X 200 | VRF200 | x | x | x | x | x | x | x | x | x | x | ✓ |
| Standard Embroidery Frame (Tubular Frame) | A | 300 x 200 | PRH300 | ✓ | ✓ | ✓ | ✓ | ✓ | ✓ | ✓ | ✓ | ✓ | ✓ | x |
| Flat Frame | A | 300 X 200 | PRF300 | ✓ | ✓ | ✓ | ✓ | ✓ | ✓ | ✓ | ✓ | ✓ | ✓ | x |
| Extra Large Embroidery Frame | A | 360 X 200 | PRPH360 | ✓ | ✓ | ✓ | x | x | x | x | x | x | x | x |
| Embroidery Frame Holder A (With White Corner Covers) | A | N/A | XE7374001 | ✓ | ✓ | ✓ | x | x | x | x | x | x | x | x |
| Embroidery Frame Holder A (With White Corner Covers) | A | N/A | XF2222001 | x | x | x | ✓ | ✓ | ✓ | ✓ | ✓ | ✓ | x | x |
| Embroidery Frame Holder a | a | N/A | XG1546001 | x | x | x | x | x | x | x | x | x | x | ✓ |
| Embroidery Frame Holder A (With White Corner Covers) | N/A | N/A | XD0637052 | x | x | x | x | x | x | x | x | x | ✓ | x |
| Sleeve Frame | B | 70 X 200 | PRHSL200 | ✓ | ✓ | x | ✓ | ✓ | x | x | x | x | x | x |
| Quilt Frame | B | 200 X 200 | PRPQF200 | ✓ | ✓ | ✓ | ✓ | ✓ | ✓ | x | x | x | x | x |
| Border Frame | B | 300 X 100 | PRPBF1 | ✓ | ✓ | ✓ | ✓ | ✓ | ✓ | x | x | x | x | x |
| Jumbo Frame | B | 360 X 360 | PRPJF360 | ✓ | ✓ | ✓ | x | x | x | x | x | x | x | x |
| Border Frame Set + Embroidery Frame Holder b | b | 180 X 100 | VRBF180 | x | x | x | x | x | x | x | x | x | x | ✓ |
| Embroidery Frame Holder B | B | N/A | XF2223001 | x | x | x | ✓ | ✓ | ✓ | x | x | x | x | x |
| Embroidery Frame Holder B (With Light Grey Corner Covers) | B | N/A | XE7376001 | ✓ | ✓ | ✓ | x | x | x | x | x | x | x | x |
| Round Frame Set | C | Ø100, 130, 160 + Frame Holder | PRPRFK1 | ✓ | ✓ | ✓ | ✓ | ✓ | ✓ | x | x | x | x | x |
| Round Frame Set + Embroidery Frame Holder c | c | Ø100, 130, 160 + Frame Holder | VRRFK1 | x | x | x | x | x | x | x | x | x | x | ✓ |
| Round Frame 100mm | C/c | Ø100 | PRPRF100 | ✓ | ✓ | ✓ | ✓ | ✓ | ✓ | x | x | x | x | ✓ |
| Round Frame 130mm | C/c | Ø130 | PRPRF130 | ✓ | ✓ | ✓ | ✓ | ✓ | ✓ | x | x | x | x | ✓ |
| Round Frame 160mm | C/c | Ø160 | PRPRF160 | ✓ | ✓ | ✓ | ✓ | ✓ | ✓ | x | x | x | x | ✓ |
| Embroidery Frame Holder C (With Dark Gray Covers) | C | N/A | PRPARMC | ✓ | ✓ | ✓ | ✓ | ✓ | ✓ | x | x | x | x | x |
| Embroidery Frame Holder c | c | N/A | XG1552101 | x | x | x | x | x | x | x | x | x | x | ✓ |

PR and VR Accessories continued

PR Frame holders are always a capital letter A,B,C,D,E,F. VR Frame holders are always a lower case letter a,b,c,d,e

| Accessory Name | Frame Holder | Frame Size (mm) | Order Code | PR1055 | PR1050X | PR1000 | PR680 | PR670E | PR655 | PR650/E | PR620 | PR600II | PR600 | VR |
|--|--------------|--|-------------------------|--------|---------|--------|-------|--------|-------|---------|-------|---------|-------|----|
| Clamp Frame S Straight Set | D | 45 X 24 | PRCLP45B | ✓ | ✓ | ✓ | ✓ | ✓ | ✓ | x | x | x | x | x |
| Clamp Frame S Straight | D | 45 X 24 | Not available in Europe | ✓ | ✓ | ✓ | ✓ | ✓ | ✓ | x | x | x | x | x |
| Clamp Frames S (L and R) Set | D | 45 X 24 | Not available in Europe | ✓ | ✓ | ✓ | ✓ | ✓ | ✓ | x | x | x | x | x |
| Clamp Frames S (L and R) | D | 45 X 24 | PRCLP45LR | ✓ | ✓ | ✓ | ✓ | ✓ | ✓ | x | x | x | x | x |
| Clamp Frame M set | D | 100 X 100 | PRCLP100B | ✓ | ✓ | ✓ | ✓ | ✓ | ✓ | x | x | x | x | x |
| Clamp Frame S | d | 45 X 24 | VRCLP45B | x | x | x | x | x | x | x | x | x | x | ✓ |
| Clamp Frame M set | d | 100 X 100 | VRCLP100B | x | x | x | x | x | x | x | x | x | x | ✓ |
| Clamp hoop M assy | d | 100 X 100 | XG5597001 | x | x | x | x | x | x | x | x | x | x | ✓ |
| Frame Holder D | D | N/A | XF2202001 | ✓ | ✓ | ✓ | ✓ | ✓ | ✓ | x | x | x | x | x |
| Frame Holder d | d | N/A | XG1554001 | x | x | x | x | x | x | x | x | x | x | ✓ |
| Compact Frame Set | E | Compact Frame 70 - 70 X 41 Compact Frame 50 - 50 X 50 Compact Frame 44 - 44 X 38 Compact Frame Vertical - 33 X 75 | PRSFK1 | ✓ | ✓ | ✓ | ✓ | ✓ | ✓ | x | x | x | x | x |
| Compact Frame 70 | E/e | 70 X 41 | VRSF70 | ✓ | ✓ | ✓ | ✓ | ✓ | ✓ | x | x | x | x | ✓ |
| Compact Frame 50 | E/e | 50 X 50 | VRSF50 | ✓ | ✓ | ✓ | ✓ | ✓ | ✓ | x | x | x | x | ✓ |
| Compact Frame 44 | E/e | 44 X 38 | VRSF44 | ✓ | ✓ | ✓ | ✓ | ✓ | ✓ | x | x | x | x | ✓ |
| Compact Frame Vertical | E/e | 33 X 75 | VRSFV | ✓ | ✓ | ✓ | ✓ | ✓ | ✓ | x | x | x | x | ✓ |
| Embroidery Frame Holder e | e | N/A | XG2408001 | x | x | x | x | x | x | x | x | x | x | ✓ |
| Embroidery Frame Holder E | E | N/A | XG5434001 | ✓ | ✓ | ✓ | ✓ | ✓ | ✓ | x | x | x | x | x |
| Magnetic Frame Set | E | 50 X 50 | PRMFA50 | ✓ | ✓ | ✓ | ✓ | ✓ | ✓ | x | x | x | x | x |
| Magnetic Frame | E/e | 50 X 50 | PRMF50 | ✓ | ✓ | ✓ | ✓ | ✓ | ✓ | x | x | x | x | ✓ |
| Free Arm Mounting Jig For Magnetic or Compact Frames | N/A | N/A | PRMFJ1 | ✓ | ✓ | ✓ | ✓ | ✓ | ✓ | x | x | x | x | x |

PR and VR Accessories continued

PR Frame holders are always a capital letter A,B,C,D,E,F. VR Frame holders are always a lower case letter a,b,c,d,e

| Accessory Name | Frame Holder | Frame Size (mm) | Order Code | PR1055 | PR1050X | PR1000 | PR680 | PR670E | PR655 | PR650/E | PR620 | PR600II | PR600 | VR |
|-------------------------------------|----------------------|--|------------|--------|---------|--------|-------|--------|-------|---------|-------|---------|-------|----|
| Versatile Magnetic Frame L Kit | F | 180 x 130 | PRVMFLKIT | ✓ | ✓ | ✓ | ✓ | ✓ | ✓ | x | x | x | x | x |
| Versatile Magnetic Frame | F | 180 x 130 | PRVMFL | ✓ | ✓ | ✓ | ✓ | ✓ | ✓ | x | x | x | x | x |
| Versatile Magnetic Frame M Kit | F | 100 X 100 | PRVMFMKIT | ✓ | ✓ | ✓ | ✓ | ✓ | ✓ | x | x | x | x | x |
| Versatile Magnetic Frame | F | 100 X 100 | PRVMFM | ✓ | ✓ | ✓ | ✓ | ✓ | ✓ | x | x | x | x | x |
| Wide Cap Frame Set | No Frame holder used | 360 X 60 | PRPCF1 | ✓ | ✓ | ✓ | x | x | x | x | x | x | x | x |
| Wide Cap Frame | No Frame holder used | 360 X 60 | PRPCFH4 | ✓ | ✓ | ✓ | x | x | x | x | x | x | x | x |
| Advanced Cap Frame Set | No Frame holder used | 130 X 50 | PRCF2 | ✓ | ✓ | ✓ | ✓ | ✓ | ✓ | ✓ | ✓ | ✓ | ✓ | x |
| Advanced Cap Frame | No Frame holder used | 130 X 50 | PRCFH2 | ✓ | ✓ | ✓ | ✓ | ✓ | ✓ | ✓ | ✓ | ✓ | ✓ | x |
| Cap Frame | No Frame holder used | 130 X 60 | PRCFH3 | ✓ | ✓ | ✓ | ✓ | ✓ | ✓ | ✓ | ✓ | ✓ | ✓ | ✓ |
| Mounting Jig (For Cap Frame PRCFH3) | No Frame holder used | N/A | PRCFJ2 | ✓ | ✓ | ✓ | ✓ | ✓ | ✓ | ✓ | ✓ | ✓ | ✓ | ✓ |
| Cap Frame (Set) | No Frame holder used | 130 X 60 | PRCF3 | ✓ | ✓ | ✓ | ✓ | ✓ | ✓ | ✓ | ✓ | ✓ | ✓ | ✓ |
| Flat Brim Cap Frame | No Frame holder used | 130 X 60 | PRCFH5 | ✓ | ✓ | ✓ | ✓ | ✓ | ✓ | ✓ | ✓ | x | x | ✓ |
| Flat Brim Cap Frame (Set) | No Frame holder used | 130 X 60 | PRCF5 | ✓ | ✓ | ✓ | ✓ | ✓ | ✓ | ✓ | ✓ | x | x | ✓ |
| Magnetic Sash Frame | No Frame holder used | PR10 needle = 360 X 200 PR6 needle = 300 X 200 The same frame is used for both series Only the max frame size changes | PRMS360 | ✓ | ✓ | ✓ | ✓ | ✓ | ✓ | ✓ | x | x | x | x |
| Cylinder Frame | No Frame holder used | 90 X 80 | PRCLH1 | ✓ | ✓ | ✓ | ✓ | ✓ | ✓ | ✓ | ✓ | ✓ | ✓ | ✓ |
| Cylinder Frame Set | No Frame holder used | 90 X 80 | PRCL1 | ✓ | ✓ | ✓ | ✓ | ✓ | ✓ | ✓ | ✓ | ✓ | ✓ | ✓ |
| Wide Table | No Frame holder used | N/A | PRWT1 | ✓ | ✓ | ✓ | ✓ | ✓ | ✓ | ✓ | ✓ | ✓ | ✓ | x |
| Wide Table | No Frame holder used | N/A | VRWT1 | x | x | x | x | x | x | x | x | x | x | ✓ |
| Free Motion Kit | No Frame holder used | N/A | VRFMK1 | x | x | x | x | x | x | x | x | x | x | ✓ |

PR and VR Accessories continued

PR Frame holders are always a capital letter A,B,C,D,E,F. VR Frame holders are always a lower case letter a,b,c,d,e

| Accessory Name | Frame Holder | Frame Size (mm) | Order Code | PR1055 | PR1050X | PR1000 | PR680 | PR670E | PR655 | PR650/E | PR620 | PR600II | PR600 | VR |
|-------------------------------|----------------------|-----------------|--------------|--------|---------|--------|-------|--------|-------|---------|-------|---------|-------|----|
| Scan Frame | No Frame holder used | N/A | XG5300001 | ✓ | ✓ | x | x | x | x | x | x | x | x | x |
| Scan Frame Set (with Magnets) | No Frame holder used | N/A | PRSCAN-FKIT1 | ✓ | ✓ | x | x | x | x | x | x | x | x | x |
| Tubular Frame table | No Frame holder used | N/A | PRTT1 | ✓ | ✓ | ✓ | ✓ | ✓ | ✓ | ✓ | ✓ | x | x | ✓ |
| Embroidery Stand | No Frame holder used | N/A | VRPRNSTD | ✓ | ✓ | ✓ | ✓ | ✓ | ✓ | ✓ | ✓ | ✓ | ✓ | ✓ |

Embroidery Sheets

| Accessory Name | Size | Order Code | PR1055 | PR1050 | PR1000 | PR680 | PR670 | PR655 | PR650 | PR620 | PR600II | PR600 | VR |
|--------------------------------|-----------|------------|--------|--------|--------|-------|-------|-------|-------|-------|---------|-------|----|
| Embroidery sheet (Extra Large) | 360 X 200 | XE7156101 | ✓ | ✓ | ✓ | x | x | x | x | x | x | x | x |
| Embroidery sheet (Extra Large) | 300 X 200 | XC5704051 | ✓ | ✓ | ✓ | ✓ | ✓ | ✓ | ✓ | ✓ | ✓ | ✓ | x |
| Embroidery sheet (Extra Large) | 200 X 200 | XE7171001 | x | x | x | x | x | x | x | x | x | x | ✓ |
| Embroidery sheet (Large) | 180 X 130 | XC5721051 | ✓ | ✓ | ✓ | ✓ | ✓ | ✓ | ✓ | ✓ | ✓ | ✓ | ✓ |
| Embroidery sheet (Medium) | 100 X 100 | XC5759051 | ✓ | ✓ | ✓ | ✓ | ✓ | ✓ | ✓ | ✓ | ✓ | ✓ | ✓ |
| Embroidery sheet (Small) | 60 X 40 | XC5761051 | ✓ | ✓ | ✓ | ✓ | ✓ | ✓ | ✓ | ✓ | ✓ | ✓ | ✓ |

brother
at your side