

# Operation Manual

Embroidery Machine

Product Code: 882-W83/W85



Be sure to read this document before using the machine.  
We recommend that you keep this document nearby for future reference. The latest manuals are available at  
Brother Support website ( <https://s.brother/cmeaf/> ).



## INTRODUCTION

Thank you for purchasing this machine. Before using this machine, carefully read the "IMPORTANT SAFETY INSTRUCTIONS", and then study this manual for the correct operation of the various functions.

In addition, after you have finished reading this manual, store it where it can quickly be accessed for future reference.

## IMPORTANT SAFETY INSTRUCTIONS

Please read these safety instructions before attempting to use the machine.

### DANGER

- To reduce the risk of electric shock

- 1 Always unplug the machine from the electrical outlet immediately after using, cleaning, making any user servicing adjustments mentioned in this manual, or if you are leaving the machine unattended.

### WARNING

- To reduce the risk of burns, fire, electrical shock, or injury to persons.

- 2 Always unplug the machine from the electrical outlet, or when making any adjustments mentioned in the instruction manual.
  - To unplug the machine, switch the machine to the symbol "O" position to turn it off, then grasp the plug and pull it out of the electrical outlet. Do not pull on the cord.
  - Plug the machine directly into the electrical outlet. Do not use an extension cord.
  - Always unplug your machine if there is a power failure.

### 3 Electrical Hazards:

- This machine should be connected to an AC power source within the range indicated on the rating label. Do not connect it to a DC power source or inverter. If you are not sure what kind of power source you have, contact a qualified electrician.
- This machine is approved for use in the country of purchase only.

- 4 Never operate this machine if it has a damaged cord or plug, if it is not working properly, has been dropped or damaged, or water is spilled on the unit. Return the machine to the nearest authorized Brother dealer for examination, repair, electrical or mechanical adjustment.

- While the machine is stored or in use if you notice anything unusual, such as an odor, heat, discoloration or deformation, stop using the machine immediately and unplug the power cord.
- When transporting the machine, be sure to carry it by its handle. Lifting the machine by any other part may damage the machine or result in the machine falling, which could cause injuries.
- When lifting the machine, be careful not to make any sudden or careless movements, which may cause a personal injury.

### 5 Always keep your work area clear:

- Never operate the machine with any air openings blocked. Keep ventilation openings of the machine free from the build up of lint, dust, and loose cloth.
- Never drop or insert foreign object into any opening.
- Do not operate where aerosol (spray) products are being used or where oxygen is being administered.
- Do not use the machine near a heat source, such as a stove or iron; otherwise, the machine, power cord or garment being embroidered may ignite, resulting in fire or an electric shock.
- Do not place this machine on an unstable surface, such as an unsteady or slanted table, otherwise the machine may fall, resulting in injuries.

## 6 Special care is required when embroidering:

- Always pay close attention to the needle. Do not use bent or damaged needles.
- Keep fingers away from all moving parts. Special care is required around the machine needle.
- Switch the machine to the symbol "O" position to turn it off when making any adjustments in the needle area.
- Do not use a damaged or incorrect needle plate, as it could cause the needle to break.
- Do not push or pull the fabric when embroidering.

## 7 This machine is not a toy:

- Your close attention is necessary when the machine is used by or near children.
- This product contains small parts. Keep the product out of the reach of children to prevent accidental ingestion of small parts.
- The plastic bag that this machine was supplied in should be kept out of the reach of children or disposed of. Never allow children to play with the bag due to the danger of suffocation.
- Do not use the seam ripper in any other way than how it is intended.
- Do not use outdoors.

## 8 For a longer service life:

- When using and storing this machine, avoid direct sunlight and high humidity locations. Do not use or store the machine near a space heater, iron, halogen lamp, or other hot objects.
- Do not use cleansers or organic solvents, such as thinner, petroleum ether or alcohol, to clean the machine. Otherwise, the finish may peel off or become scratched.
- Always consult the Operation Manual when replacing or installing any assemblies, the presser feet, needle, or other parts to assure correct installation.

## 9 For repair or adjustment:

- If the light unit is damaged, it must be replaced by an authorized Brother dealer.
- In the event a malfunction occurs or adjustment is required, first follow the troubleshooting table in the back of the Operation Manual to inspect and adjust the machine yourself. If the problem persists, please consult your local authorized Brother dealer.

**Use this machine only for its intended use as described in the manual.**

**Use accessories recommended by the manufacturer as contained in this manual.**

**The contents of this manual and specifications of this product are subject to change without notice.**

**For additional product information and updates, visit our website at [www.brother.com](http://www.brother.com)**

# **SAVE THESE INSTRUCTIONS**

## **This machine is intended for household use.**

### **FOR USERS IN COUNTRIES EXCEPT EUROPEAN COUNTRIES**

This appliance is not intended for use by persons (including children) with reduced physical, sensory or mental capabilities, or lack of experience and knowledge, unless they have been given supervision or instruction concerning use of the appliance by a person responsible for their safety. Children should be supervised to ensure that they do not play with the appliance.

### **FOR USERS IN EUROPEAN COUNTRIES**

This appliance can be used by children aged from 8 years and above and persons with reduced physical, sensory or mental capabilities or lack of experience and knowledge if they have been given supervision or instruction concerning use of the appliance in a safe way and understand the hazards involved. Children shall not play with the appliance. Cleaning and user maintenance shall not be made by children without supervision.



# FOR USERS IN THE UK, EIRE, MALTA AND CYPRUS ONLY

## IMPORTANT

- In the event of replacing the plug fuse, use a fuse approved by ASTA to BS 1362, i.e. carrying the  mark, rating as marked on plug.
- Always replace the fuse cover. Never use plugs with the fuse cover omitted.
- If the available electrical outlet is not suitable for the plug supplied with this equipment, you should contact your authorized Brother dealer to obtain the correct lead.

## Federal Communications Commission (FCC) Supplier's Declaration of Conformity (For U.S.A. Only)

Responsible Party: Brother International Corporation  
200 Crossing Boulevard  
P.O. Box 6911  
Bridgewater, NJ 08807-0911  
USA  
TEL : (908) 704-1700

declares that the product

Product Name: Brother Embroidery Machine  
Model Number: XE2

This device complies with Part 15 of the FCC Rules. Operation is subject to the following two conditions: (1) this device may not cause harmful interference, and (2) this device must accept any interference received, including interference that may cause undesired operation.

This equipment has been tested and found to comply with the limits for a Class B digital device, pursuant to Part 15 of the FCC Rules. These limits are designed to provide reasonable protection against harmful interference in a residential installation. This equipment generates, uses, and can radiate radio frequency energy and, if not installed and used in accordance with the instructions, may cause harmful interference to radio communications. However, there is no guarantee that interference will not occur in a particular installation. If this equipment does cause harmful interference to radio or television reception, which can be determined by turning the equipment off and on, the user is

encouraged to try to correct the interference by one or more of the following measures:

- Reorient or relocate the receiving antenna.
- Increase the separation between the equipment and receiver.
- Connect the equipment into an outlet on a circuit different from that to which the receiver is connected.
- Consult the authorized Brother dealer or an experienced radio/TV technician for help.
- This transmitter must not be co-located or operated in conjunction with any other antenna or transmitter.

## Important

Changes or modifications not expressly approved by Brother Industries, Ltd. could void the user's authority to operate the equipment.

This equipment complies with FCC/IC radiation exposure limits set forth for an uncontrolled environment and meets the FCC radio frequency (RF) Exposure Guidelines and RSS-102 of the IC radio frequency (RF) Exposure rules. This equipment should be installed and operated keeping the radiator at least 20cm or more away from person's body.

## For Users in Canada

This device complies with Industry Canada's licence-exempt RSSs. Operation is subject to the following two conditions:

- (1) This device may not cause interference; and
- (2) This device must accept any interference, including interference that may cause undesired operation of the device.

This equipment complies with FCC/IC radiation exposure limits set forth for an uncontrolled environment and meets the FCC radio frequency (RF) Exposure Guidelines and RSS-102 of the IC radio frequency (RF) Exposure rules. This equipment should be installed and operated keeping the radiator at least 20cm or more away from person's body.

## For Users in Mexico

The operation of this equipment is subject to the following two conditions:

- (1) it is possible that this equipment or device may not cause harmful interference, and
- (2) this equipment or device must accept any interference, including interference that may cause undesired operation.

## Para usuarios en México

La operación de este equipo está sujeta a las siguientes dos condiciones:

- (1) es posible que este equipo o dispositivo no cause interferencias perjudiciales y
- (2) este equipo o dispositivo debe aceptar cualquier interferencia, incluyendo la que pueda causar su operación no deseada.

## Declaration of Conformity (Europe and Turkey only)

We, Brother Industries, Ltd. 15-1 Naeshiro-cho, Mizuho-ku, Nagoya 467-8561 Japan declare that this product is in conformity with the essential requirements of all relevant directives and regulations applied within the European Community.

The Declaration of Conformity (DoC) can be downloaded from Brother Support website. Visit [support.brother.com](http://support.brother.com)

## Declaration of Conformity for RE Directive 2014/53/ EU (Europe and Turkey only) (Applicable to models with radio interfaces)

We, Brother Industries, Ltd. 15-1 Naeshiro-cho, Mizuho-ku, Nagoya 467-8561 Japan declare that these products are in conformity with the provisions of the RE Directive 2014/53/EU.

The Declaration of Conformity (DoC) can be downloaded from Brother Support website. Visit [support.brother.com](http://support.brother.com)

## Wireless LAN (Models with Wireless LAN function only)

This machine supports wireless interface.

Frequency band(s): 2400-2483.5 MHz

Maximum radio-frequency power transmitted in the frequency band(s): Less than 20 dBm(e.i.r.p)

## UK Declaration of Conformity (Great Britain only)

We, Brother Industries, Ltd. 15-1 Naeshiro-cho, Mizuho-ku, Nagoya 467-8561 Japan declare that these products are in conformity with the relevant UK legislation.

The Declaration of Conformity (DoC) can be downloaded from Brother Support website. Visit [support.brother.com](http://support.brother.com)

## UK Declaration of Conformity for Radio Equipment Regulation 2017

### (Great Britain only) (Applicable to models with radio interfaces)

We, Brother Industries, Ltd. 15-1 Naeshiro-cho, Mizuho-ku, Nagoya 467-8561 Japan declare that these products are in conformity with the provisions of the Radio Equipment Regulation 2017.

The Declaration of Conformity (DoC) can be downloaded from Brother Support website. Visit [support.brother.com](http://support.brother.com)

## For Users in Norway

This subsection does not apply for the geographical area within a radius of 20 km from the centre of Ny-Alesund on Svalbard.

Dette underavsnittet gjelder ikke for det geografiske området innenfor en radius av 20 km fra sentrum av Ny-Ålesund på Svalbard.

---

## TRADEMARKS

WPA™ and WPA2™ are trademarks of Wi-Fi Alliance®.

Any trade names and product names of companies appearing on Brother products, related documents and any other materials are all trademarks or registered trademarks of those respective companies.

## COPYRIGHT AND LICENSE

This product includes software developed by the following vendor: ©2008 Devicescape Software, Inc.

## OPEN SOURCE LICENSING REMARKS

This product includes open-source software. To see the open source licensing remarks, please go to the manual download section on your model's home page of Brother Support website at <https://s.brother/cpeag/>.

## PRECAUTION FOR WIRELESS CONNECTION

Make sure you use a router or firewall when connecting your machine to the Internet to protect it against unauthorized access from the Internet.

## CONTENTS

<b>Chapter 1 GETTING READY</b>	<b>9</b>	<b>Chapter 3 ADVANCED EMBROIDERY</b>	<b>71</b>
<b>NAMES OF MACHINE PARTS</b> .....	<b>9</b>	<b>VARIOUS EMBROIDERING FUNCTIONS</b> .....	<b>71</b>
<b>INCLUDED ACCESSORIES</b> .....	<b>10</b>	Basting Embroidery .....	71
<b>TURNING THE MACHINE ON/OFF</b> .....	<b>10</b>	Creating an Appliqué Piece .....	72
<b>LCD SCREEN</b> .....	<b>12</b>	<b>MAKING EMBROIDERY ADJUSTMENTS</b> .....	<b>75</b>
Using the Machine Settings Key .....	13	Adjusting Thread Tension .....	75
Using the Machine Help .....	17	Adjusting the Bobbin Case.....	76
<b>WIRELESS NETWORK CONNECTION</b>		Using the Automatic Thread Cutting Function	
<b>FUNCTIONS</b> .....	<b>18</b>	(End Color Trim) .....	77
Operations Available with a Wireless Network Connection ...	18	Using the Thread Trimming Function (Jump Stitch Trim) .....	78
Enabling a Wireless Network Connection.....	19	Adjusting the Embroidery Speed .....	78
Using the Wizard to Set Up the Wireless Network		Changing the Thread Color Display .....	79
Connection .....	19	Aligning the Pattern and the Needle .....	79
<b>CONNECTING THE ACCESSORY TO THE</b>		Embroidering Linked Characters .....	80
<b>MACHINE</b> .....	<b>21</b>	<b>USING THE MEMORY FUNCTION</b> .....	<b>81</b>
Using a USB Mouse .....	21	Saving Embroidery Patterns.....	81
<b>WINDING/INSTALLING THE BOBBIN</b> .....	<b>22</b>	Retrieving Embroidery Patterns .....	82
Winding the Bobbin .....	22	<b>EMBROIDERY APPLICATIONS</b> .....	<b>83</b>
Setting the Bobbin .....	25	Using a Frame Pattern To Make an Appliqué .....	83
<b>UPPER THREADING</b> .....	<b>26</b>	Embroidering Couching Patterns .....	84
Upper Threading.....	26	Creating Stippling, Echo Quilting, or Decorative Fill Patterns	
<b>CHANGING THE NEEDLE</b> .....	<b>29</b>	around a Design .....	87
		Embroidering Split Embroidery Patterns .....	88
<b>Chapter 2 BASIC EMBROIDERY</b>	<b>31</b>	<b>Chapter 4 MY DESIGN CENTER</b>	<b>89</b>
<b>BEFORE EMBROIDERING</b> .....	<b>31</b>	<b>ABOUT MY DESIGN CENTER</b> .....	<b>89</b>
Embroidery Step by Step.....	31	<b>PATTERN DRAWING SCREEN</b> .....	<b>89</b>
About the Embroidery Unit.....	31	Before Creating Designs.....	91
<b>SELECTING PATTERNS</b> .....	<b>33</b>	Drawing Lines .....	91
Selecting Embroidery Patterns .....	33	Drawing Regions .....	92
Selecting Character Patterns .....	35	Using the Stamp Key.....	93
Selecting Frame Patterns.....	36	Using the Erase Key .....	94
Combining Patterns .....	37	Using the Select Key .....	94
<b>EDITING PATTERNS</b> .....	<b>39</b>	<b>STITCH SETTINGS SCREEN</b> .....	<b>95</b>
Previewing the Pattern.....	41	Specifying Individual Stitch Settings .....	95
Changing the Size and the Density of the Pattern .....	41	Specifying Global Stitch Settings.....	96
Creating Repeated Patterns .....	42	Loading the Background Image.....	97
Embroidering the Pattern Repeatedly.....	45	<b>LINE CONVERSION</b> .....	<b>98</b>
Deselect Region Setting (No Sew Setting) .....	46	Create a Pattern with Line Conversion .....	98
<b>EDITING COLORS</b> .....	<b>48</b>	<b>ILLUSTRATION CONVERSION</b> .....	<b>100</b>
Changing the Thread Color .....	48	Create a Pattern with Illustration Conversion .....	100
Finding New Color Schemes with the Color Shuffling		<b>STIPLING</b> .....	<b>102</b>
Function .....	49	Basic Stippling with My Design Center .....	102
Thread Color Sorting .....	50	Decorative Stitching around a Pattern in Embroidery	
<b>VIEWING THE EMBROIDERY SCREEN</b> .....	<b>51</b>	(a Quilting Function).....	104
<b>PREPARING THE FABRIC</b> .....	<b>53</b>	<b>MY STITCH MONITOR APP</b> .....	<b>106</b>
Attaching Iron-on Stabilizers (Backing) to the Fabric.....	53	<b>MY DESIGN SNAP APP</b> .....	<b>107</b>
Hooping the Fabric in the Embroidery Frame .....	54	<b>ARTSPIRA APP COMPATIBLE</b> .....	<b>108</b>
<b>ATTACHING THE EMBROIDERY FRAME</b> .....	<b>56</b>	<b>Chapter 5 APPENDIX</b>	<b>109</b>
<b>CONFIRMING THE PATTERN POSITION</b> .....	<b>57</b>	<b>CARE AND MAINTENANCE</b> .....	<b>109</b>
Checking the Needle Drop Point with the Embroidery Foot “W+”		Cleaning the LCD .....	109
with LED Pointer .....	57	Cleaning the machine surface.....	109
Displaying a Background Image .....	58	Restrictions on Oiling .....	109
Checking the Pattern Position.....	60	Precautions on Storing the Machine.....	109
<b>THE 2-POINT EMBROIDERY POSITIONING</b>		Cleaning the Race .....	109
<b>FUNCTION</b> .....	<b>61</b>	Cleaning the Cutter in the Bobbin Case Area .....	110
<b>EMBROIDERING A PATTERN</b> .....	<b>65</b>	Changing Embroidery Foot “W+” with LED Pointer .....	111
Embroidering Attractive Finishes .....	65	<b>BEFORE LENDING OR DISPOSING OF THE</b>	
Embroidering Patterns .....	65	<b>PRODUCT</b> .....	<b>112</b>
Using Appliqués.....	67	<b>ADJUSTING THE SCREEN</b> .....	<b>112</b>
<b>ADJUSTMENTS DURING THE EMBROIDERY</b>		Touch Panel is Malfunctioning .....	112
<b>PROCESS</b> .....	<b>68</b>	<b>TROUBLESHOOTING</b> .....	<b>113</b>
If the Thread Breaks or the Bobbin Runs out of Thread During		If the Thread Becomes Tangled Under the Bobbin	
Embroidering.....	68	Winder Seat.....	113
Resuming Embroidery after Turning off the Power .....	69	List of Symptoms.....	113

**ERROR MESSAGES ..... 117**  
**SPECIFICATIONS ..... 119**  
**UPDATING YOUR MACHINE'S SOFTWARE... 121**  
    Update Procedure Using USB Media ..... 121  
    Update Procedure Using Wireless LAN Connection..... 121  
**INDEX ..... 123**





# Chapter 1 GETTING READY

**Note**

- Be sure to install the latest software. Refer to “UPDATING YOUR MACHINE’S SOFTWARE” on page 121.

## NAMES OF MACHINE PARTS

■ Main Parts

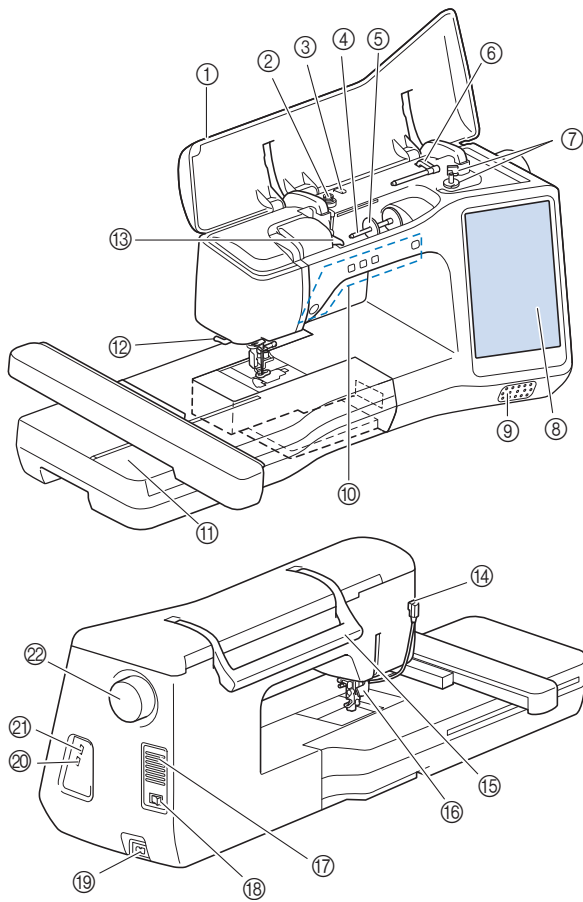

- ① Top cover
- ② Pretension disk (page 23)
- ③ Thread guide for bobbin winding (page 23)
- ④ Spool pin (page 24)
- ⑤ Spool cap (page 22)
- ⑥ Supplemental spool pin (page 22)
- ⑦ Bobbin winder (page 22)
- ⑧ LCD (liquid crystal display) (page 12)
- ⑨ Speaker
- ⑩ Operation buttons (page 10)
- ⑪ Embroidery unit (page 32)
- ⑫ Thread cutter (page 28)
- ⑬ Thread guide plate (page 24)
- ⑭ Connector for the presser foot (page 111)
- ⑮ Handle  
Carry the machine by its handle when transporting the machine.

- ⑯ Presser foot lever  
You cannot use the presser foot lever after the presser foot has been raised using  (Presser foot lifter button).
- ⑰ Air vent  
The air vent allows the air surrounding the motor to circulate. Do not cover the air vent while the machine is being used.
- ⑱ Main power switch (page 10)
- ⑲ Power cord receptacle (page 11)
- ⑳ USB port for mouse (page 21)
- ㉑ USB port
- ㉒ Handwheel  
Turn the handwheel toward you (counterclockwise) to raise and lower the needle.

■ Needle and Presser Foot Section

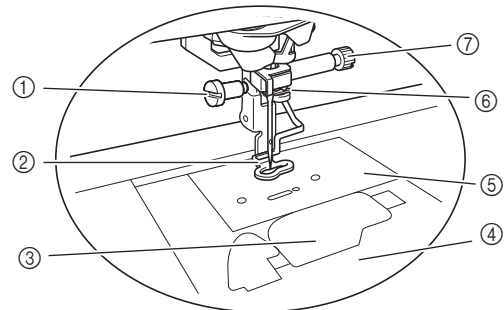

- ① Screw for embroidery foot (page 111)
- ② Embroidery foot  
The embroidery foot helps control fabric flexibility for better stitch consistency.
- ③ Bobbin cover (page 25)
- ④ Needle plate cover (page 25)
- ⑤ Needle plate (page 110)
- ⑥ Needle bar thread guide (page 27)
- ⑦ Needle clamp screw (page 29)



## ■ Operation Buttons

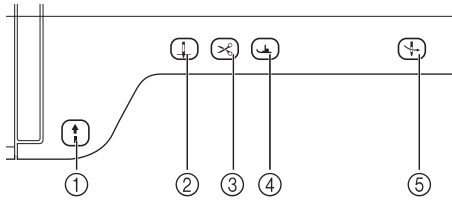

### ① “Start/Stop” button

Press the “Start/Stop” button to start or stop embroidering. The button changes color according to the machine’s operation mode.

Green: The machine is ready to embroider or is embroidering.

Red: The machine is not ready to start embroidering.

### ② Needle position button

Press the needle position button to raise or lower the needle position. Pressing the button twice embroiders a single stitch.

### ③ Thread cutter button

Press the thread cutter button after embroidering to trim the excess thread.

### ④ Presser foot lifter button

Press the presser foot lifter button to lower the presser foot and apply pressure to the fabric. Press this button again to raise the presser foot.

### ⑤ Automatic threading button

Use the automatic threading button to automatically thread the needle.

## INCLUDED ACCESSORIES

For included accessories of your machine, refer to the additional sheet “Included Accessories”.

## TURNING THE MACHINE ON/OFF

### **WARNING**

- Use only regular household electricity for the power source. Using other power sources may result in fire, electric shock, or damage to the machine.
- Do not touch the plug with wet hands. Electric shock may result.
- Make sure that the plugs on the power cord are firmly inserted into the electrical outlet and the power cord receptacle on the machine. Otherwise, a fire or electric shock may result.
- Turn the main power to OFF and remove the plug in the following circumstances:
  - When you are away from the machine
  - After using the machine
  - When the power fails during use
  - When the machine does not operate correctly due to a bad connection or a disconnection
  - During electrical storms

### **CAUTION**

- Use only the power cord included with this machine.
- Do not use extension cords or multi-plug adapters with many other appliances plugged in to them. Fire or electric shock may result.
- When unplugging the machine, always turn the main power to OFF first. Always grasp the plug to remove it from the outlet. Pulling on the cord may damage the cord, or lead to fire or electric shock.
- Do not allow the power cord to be cut, damaged, modified, forcefully bent, pulled, twisted, or bundled. Do not place heavy objects on the cord. Do not subject the cord to heat. These things may damage the cord, or cause fire or electric shock. If the cord or plug is damaged, take the machine to your authorized Brother dealer for repairs before continuing use.
- Unplug the power cord if the machine is not to be used for a long period of time. Otherwise, a fire may result.

- (For U.S.A only)  
This appliance has a polarized plug (one blade wider than the other). To reduce the risk of electrical shock, this plug is intended to fit in a polarized electrical outlet only one way. If the plug does not fit fully in the electrical outlet, reverse the plug. If it still does not fit, contact a qualified electrician to install the proper electrical outlet. Do not modify the plug in any way.

- 1 Insert the power supply cord into the power cord receptacle, then insert the plug into a wall outlet.

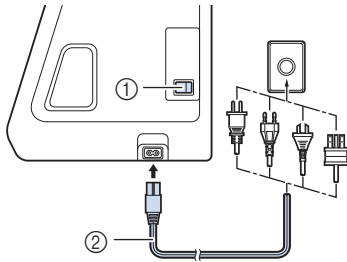

- 1 Main power switch
- 2 Power supply cord

- 2 Turn the main power switch to "I" to turn on the machine.

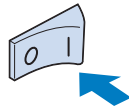

#### Memo

- The light, LCD and the "Start/Stop" button light up when the machine is turned on.

- 3 When the machine is turned on, the opening movie is played. Touch anywhere on the screen.

- 4 Turn the main power switch to "O" to turn off the machine.

### Setting Your Machine for the First Time

When you first turn on the machine, set the language and time/date to your language and local time/date.

- 1 Touch and to set your local language and then touch .

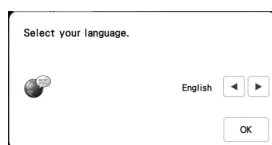

- 2 The message screen, confirming if you want to set time/date, appears. Touch .

- 3 Touch or to set time/date. And then touch .

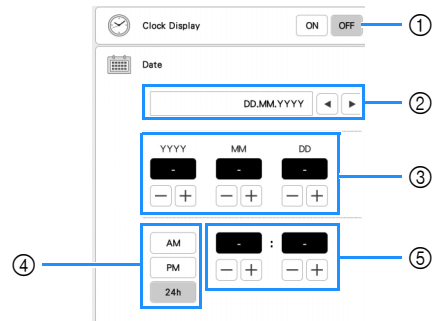

- 1 Select [ON] to display time/date on the screen.
- 2 Touch or to select the date display format.
- 3 Set the year (YYYY), month (MM) and date (DD).
- 4 Select whether 24h or 12h setting will display.
- 5 Set the current time.  
→ The clock starts from 0 second of the time you set.

#### Memo

- The time/date you set may be cleared, if you don't turn on the machine for an extended period of time.

- 4 The following message about a wireless LAN connection appears. To set up a connection, touch , and then refer to steps 3 through 6 in "Using the Wizard to Set Up the Wireless Network Connection" on page 19 to finish setting up a wireless LAN connection.

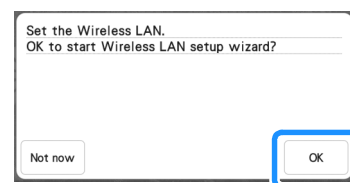

## LCD SCREEN

Touch the LCD screen or a key with your finger or the included touch pen to select a machine function.

### IMPORTANT









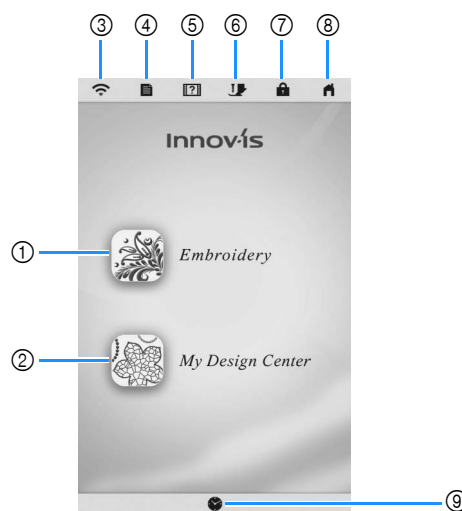

- Only touch the screen with your finger or the touch pen (stylus) included with the machine. Do not use a mechanical pencil, screwdriver or any other hard or sharp object. In addition, do not press the screen with extreme pressure. Otherwise the screen may be damaged.

#### Note





- All or part of the screen may sometimes become darker or lighter due to changes in the surrounding temperature or other changes in the environment. This is not a sign of a malfunction. If the screen is difficult to read, adjust its brightness.

### ■ Home Page Screen



No.	Display	Explanation	Page
	Name		
①		Select an embroidery pattern.	31
	Embroidery key		
②		Create an original embroidery pattern.	89
	My Design Center key		
③		Shows the machine's signal strength. Touch this key to specify the wireless settings. If there is a new update file, the key appears as  .	15, 19
	Wireless LAN key		
④		Change the needle stop position, adjust the pattern or screen, and change other machine settings.	13
	Machine settings key		
⑤		See explanations on how to use the machine. You can see the tutorial videos and also MP4 movie files that you have saved on USB media.	17
	Machine help key		
⑥		Touch this key before changing the needle, the presser foot, etc. This key locks all key and button functions to prevent operation of the machine.	25, 29
	Presser foot/Needle exchange key		
⑦		Lock the screen. When the screen is locked, you can still embroider, but cannot change any of the screen functions. Touch this key again to unlock the screen.	—
	Screen lock key		
⑧		Return to the home page screen at any time and select a different category - [Embroidery] or [My Design Center].	—
	Home page screen key		
⑨		Set the time/date.	11
	Time/Date key		



## Using the Machine Settings Key

Touch  to change the default machine settings (needle stop position, embroidery speed, opening display, etc.). To display the different settings screens, touch  for “General settings”,  for “Embroidery settings” or  for “Wireless LAN settings”.

### Note

- The machine default setting is highlighted.

### Memo

- Touch  or  to display a different settings screen.

## General Settings

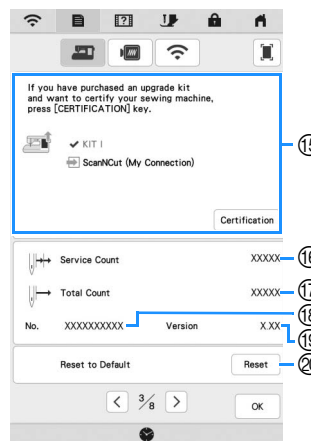
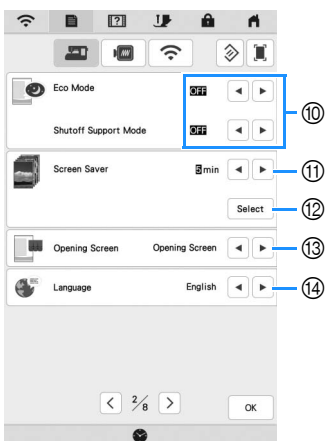
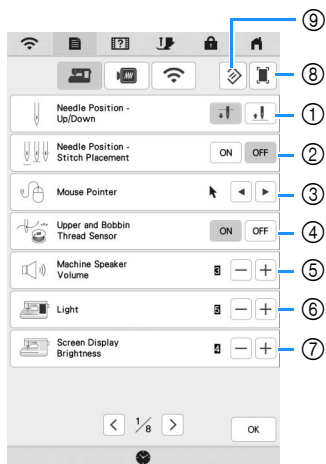

## IMPORTANT

- When [Upper and Bobbin Thread Sensor] is set to [OFF], the machine cannot detect tangled upper thread. Continuing to use the machine with tangled thread may cause damage.

- ① Select the needle stop position (the needle position when the machine is not operating) to be up or down.
- ② Select the operation of the  (Needle position button) from the following two sequences.

Each press of the  (Needle position button):

[ON] : Switches the needle position between being raised, stopped immediately before entering the fabric, or lowered.

[OFF] : Switches the needle position between being raised or lowered.

- ③ Select the shape of the pointer when a USB mouse is used.
- ④ Turn both the upper and bobbin thread sensors [ON] or [OFF]. If it is turned [OFF], the machine can be used without thread.
- ⑤ Select the speaker volume. Increase the number for louder volume, decrease for softer volume.
- ⑥ Select the brightness of the work area lights.
- ⑦ Select the screen display brightness.
- ⑧ You can save the current settings screen image in a USB media by touching this key when the USB media is inserted into the USB port. The files are saved in a folder labeled [bPocket].
- ⑨ Reset settings on this page to original default. Some settings are not reset.
- ⑩ Set the [Eco Mode] and the [Shutoff Support Mode] to save the machine power (page 15).
- ⑪ Select the length of time until the screen saver appears.
- ⑫ Select the image of the screen saver (page 16).
- ⑬ Select the initial screen that is displayed when the machine is turned on.
- ⑭ Select the display language.
- ⑮ Use to certify your machine when you use [My Connection] function with Brother cutting machine (sold separately and limited to certain sales region). For details, visit the following webpage and refer to the “My Connection” Operation Manual. <https://s.brother/cmeaf/>



KIT I has been certified on this machine.

- ⑫ Shows the service count which is a reminder to take your machine in for regular servicing. (Contact your authorized Brother dealer for details.)
- ⑬ Shows the total number of stitches embroidered on this machine.
- ⑭ Shows the internal machine number for this machine.
- ⑮ Shows the program version.
- ⑯ Erase all saved data, customized settings and network information in the machine.

## ■ Embroidery Settings

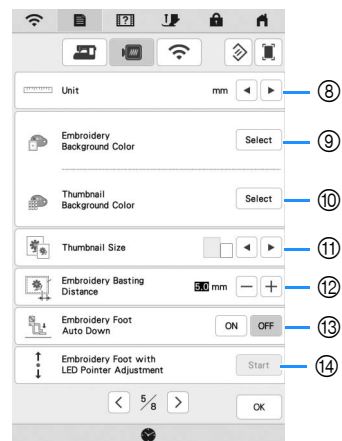
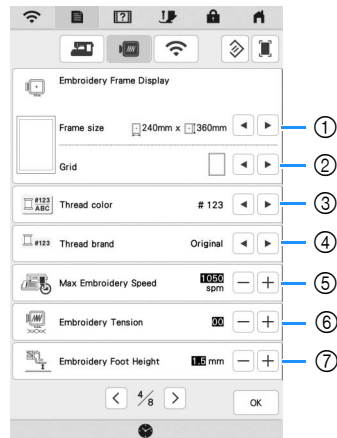

- ① Select the embroidery frame to be used.
- ② Select the center point marker or grid lines.
- ③ Select the thread color display on the embroidery screen; thread number, color name. (page 79)
- ④ Select the thread brand of the thread color display. (page 79)
- ⑤ Adjust the maximum embroidery speed (page 78).
- ⑥ Adjust the upper thread tension for embroidering (page 76).
- ⑦ Select the height of the embroidery foot during embroidering (page 53).
- ⑧ Select the display units for embroidering (mm/inch).
- ⑨ Select the color of the background for the embroidery display area.
- ⑩ Select the color of the background for the thumbnail area.
- ⑪ Select the size of pattern thumbnails.
- ⑫ Adjust the distance between the pattern and the basting stitching. (page 71)
- ⑬ When set to [ON], pressing the “Start/Stop” button when the embroidery foot is raised automatically lowers the embroidery foot before starting embroidering.
- ⑭ Adjust the position and brightness of the embroidery foot “W+” with LED pointer (this setting is available if embroidery foot “W+” with LED pointer has been attached.) (page 58)

## ■ Wireless LAN Settings

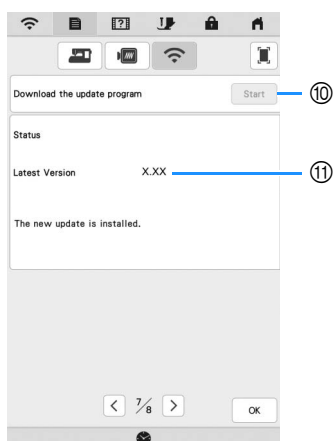
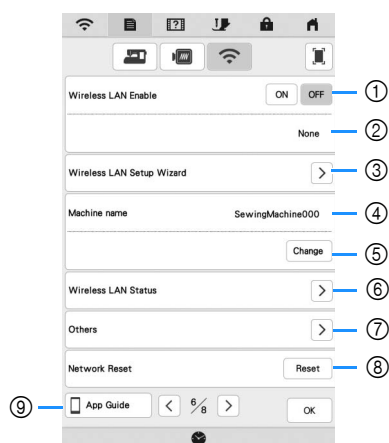

- ① Enable/Disable the wireless LAN function (page 19).
- ② Shows the connected SSID.
- ③ Set the machine to connect wireless LAN function.
- ④ Shows the machine name used on the wireless network.
- ⑤ Change the machine name used on the wireless network.
- ⑥ Check the wireless LAN status.
- ⑦ Display other menus.
- ⑧ Reset network operations.
- ⑨ Display the introduction to the applications. Touch the key of the app whose information you want to display. On smart devices with a QR reader app installed, scan the QR code to display a screen that shows how to install the app.

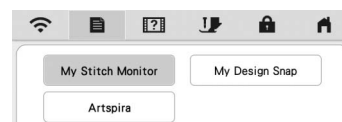

**My Stitch Monitor:** The machine's embroidering status can be monitored from your smart device. For details, refer to "MY STITCH MONITOR APP" on page 106.

**My Design Snap:** You can position your embroidery designs on the fabric, by capturing image of the hooped fabric and sending the image to your machine. For details, refer to "MY DESIGN SNAP APP" on page 107.

**Artspira:** You can transfer content published on the app to the embroidery machine and enjoy creating original works using the functions on the app.

- ⑩ If there is a new update program, download the update file. (page 121)
- ⑪ Display update program information. (page 121)
- ⑫ Register the Artspira app. (page 108)

## ■ Setting the [Eco Mode] and the [Shutoff Support Mode]

You can save the machine power by setting the [Eco Mode] and the [Shutoff Support Mode].

If you leave the machine turned on without using it for the set period of time, the machine enters in each mode.

Touch  to display [Eco Mode] and [Shutoff Support Mode]. (page 13)

### [Eco Mode];

Machine will enter a sleep mode after the set period of time. Touch the screen or press the "Start/Stop" button to continue operating.

### [Shutoff Support Mode];



Machine will enter the lower power mode after the set period of time. Turn the machine off and then back on to restart operating.

### Memo

- If you turn off the machine while the machine is in the [Eco Mode] or the [Shutoff Support Mode], wait for about 5 seconds before turning on the machine again.
- For details on condition of the [Eco Mode] and [Shutoff Support Mode], refer to "SPECIFICATIONS" on page 119.

### ■ Changing the Screen Saver Image

Instead of the default image, you can select your own personal images for the screen saver of your machine. Before changing the screen saver image, prepare the image on USB media. For details on compatible image files, refer to "SPECIFICATIONS" on page 119.

- 1 Touch  .  
→ The settings screen appears.
- 2 Touch  .  
→ The general settings screen appears.
- 3 Display [Screen Saver] in the general settings screen.

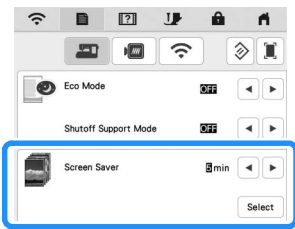

- 4 Touch  .

- 5 Touch  .

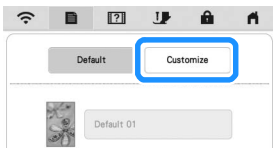

- 6 Connect the USB media that contains your personal image to the USB port of the machine.

- 7 Touch  to select the first image.

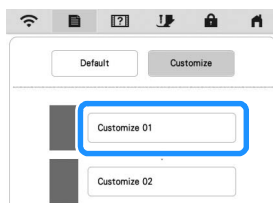

- 8 Select the device that is connected.



→ A list of your personal images appears on the screen.

- \*  : Delete the selected image.
- \*  : Return to the previous page.

- 9 Select a file name and then touch  .

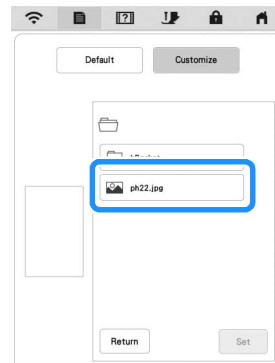

→ The selected image is stored on your machine.

- \*  : Return to the previous page.

- 10 Repeat steps 7 through 9 to set the remaining images.

- 11 Touch  to return to the original screen.

#### Memo

- Touch [Default] to select default images for the screen saver.





## Using the Machine Help

Touch to display the machine help screen. Functions are available from the screen shown below.

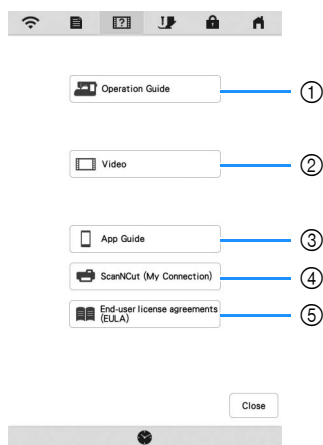

- ① Explanation for upper threading, winding the bobbin, preparing to embroider a pattern, and how to use the machine (page 17)
- ② Tutorial videos or MPEG-4 (MP4) videos (page 17, page 18)
- ③ Display the introduction to the applications. Touch the key of the app whose information you want to display. On smart devices with a QR reader app installed, scan the QR code to display a screen that shows how to install the app.



**My Stitch Monitor:** The machine's embroidering status can be monitored from your smart device. For details, refer to "MY STITCH MONITOR APP" on page 106.

**My Design Snap:** You can position your embroidery designs on the fabric, by capturing image of the hooped fabric and sending the image to your machine. For details, refer to "MY DESIGN SNAP APP" on page 107.

**Artspira:** You can transfer content published on the app to the embroidery machine and enjoy creating original works using the functions on the app.

- ④ Introduction to ScanNCut (My Connection)
- ⑤ End-user license agreements (EULA)

## Using the Operation Guide Function

Touch to display the screen shown below. Categories are displayed at the top of the screen. Touch a key to see more information about that category. Some of the functions are described in the movies. Watch these movies for a better understanding of the functions.

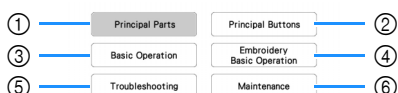

- ① Information about the main parts of the machine and their functions
- ② Information about the operation buttons
- ③ Information about threading the machine, changing needles, etc.
- ④ Information about attaching the embroidery unit, preparing fabric for embroidering, etc.
- ⑤ Information about troubleshooting
- ⑥ Information about cleaning the machine, etc.

## Playing a Tutorial Video

This machine provides tutorial videos on how to use the machine.

- 1 Touch .
- 2 Touch .
- 3 Select the category and the tutorial video.

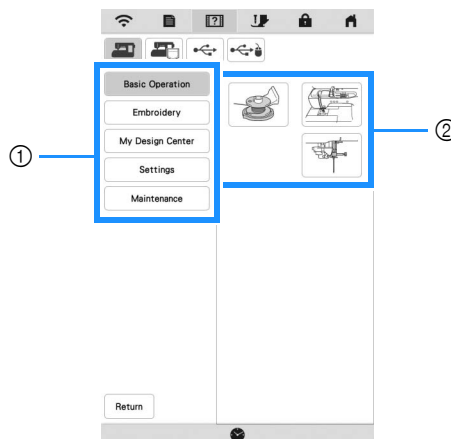

- ① Category
- ② Tutorial video

- 4 Play the tutorial video.

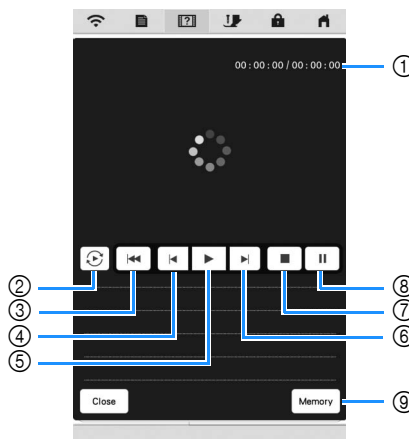

- ① Number of seconds elapsed/Total number of seconds
- ② Repeat
- ③ Return to beginning
- ④ Skip back 10 seconds
- ⑤ Play
- ⑥ Skip forward 10 seconds
- ⑦ Stop
- ⑧ Pause
- ⑨ Save to machine (when playing from USB media).

A video can be saved to (favorites) of the machine, from where it can be played.

When playing from the machine's memory, changes to .

Touch to delete the video.

### Note

- The specifications shown in the movie may differ from the ones on the actual product, in details.
- The movie includes optional parts not included with this product.

5 After you are finished playing the video, touch Close.

**Playing MPEG-4 (MP4) Videos**

Your MP4 videos can be played from USB media. In addition, the MP4 video can be saved to the machine so that a tutorial video on creating a project, for example, can be viewed at any time. For details on supported file extensions, refer to “SPECIFICATIONS” on page 119.

**Memo**

- Some types of MP4 file cannot be played with the machine.

1 Touch .

2 Touch Video.

3 Select the device where the video is saved.

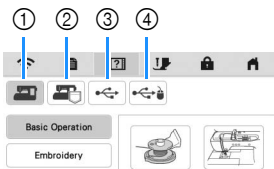

- ① Tutorial videos
- ② Videos saved on the machine (favorites)
- ③ Videos from USB media plugged into the USB port
- ④ Videos from USB media plugged into the USB port for mouse

4 Select the video that you want to play.

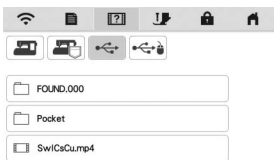

**Note**

- Long file names may be shortened when they are displayed.

5 Play the video.

\* Use the operation keys as described in “Playing a Tutorial Video” on page 17.

6 After you are finished playing the video, touch Close.

**WIRELESS NETWORK CONNECTION FUNCTIONS**

**Operations Available with a Wireless Network Connection**

This machine supports a wireless network connection. The following useful operations will be available if the machine is connected to a wireless network.

**For updating**

Directly download the update file to the machine. (page 121)

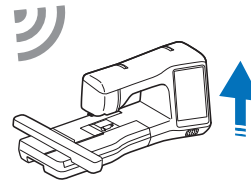

**For embroidering**

- Conveniently check the operating status of the machine from your smart device by using the dedicated mobile application (My Stitch Monitor).

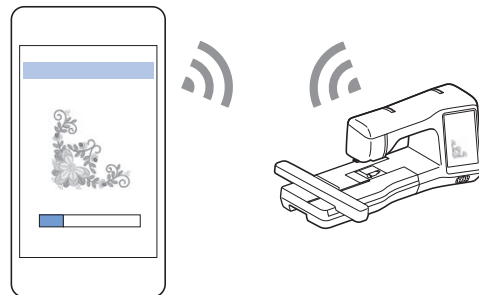

- My Design Snap: You can position your embroidery designs on the fabric, by capturing image of the hooped fabric and sending the image to your machine.

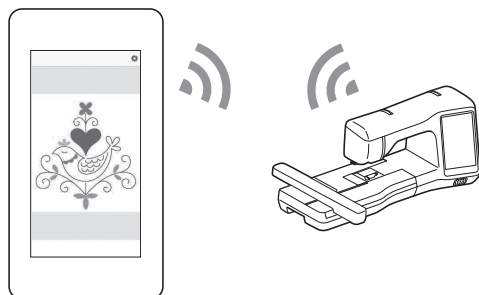

- Wirelessly transfer an embroidery pattern from your computer to the machine by using the dedicated Windows application (Design Database Transfer). The application can be downloaded from the following URL.  
<https://s.brother/caeka/>
- \* Settings must be specified in Design Database Transfer. For more information, refer to the manual for Design Database Transfer.

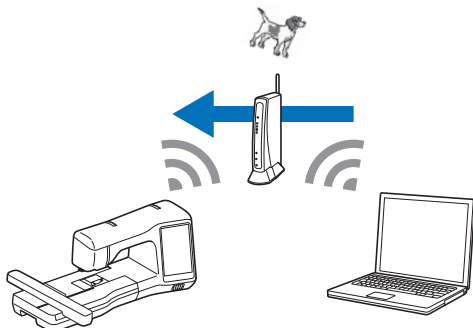

- Wirelessly transfer to the machine an embroidery pattern edited with embroidery editing software (PE-DESIGN version 11 or later) on a computer. Also, transfer to PE-DESIGN an embroidery pattern edited on the machine.
- \* Settings must be specified in PE-DESIGN. For more information, refer to the manual for PE-DESIGN.

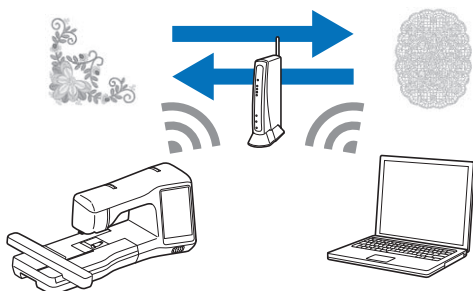

- With Artspira App, you can transfer content published on the app to the embroidery machine and enjoy creating original works using the functions on the app.
- When an updated version of the software is available on our website, the wireless LAN key appears as . (page 121)

## Enabling a Wireless Network Connection

The machine can be connected to your wireless network. Refer to "SPECIFICATIONS" on page 119 for requirements for a wireless network connection.

- 1 Touch .
- 2 Set [Wireless LAN Enable] to [ON].

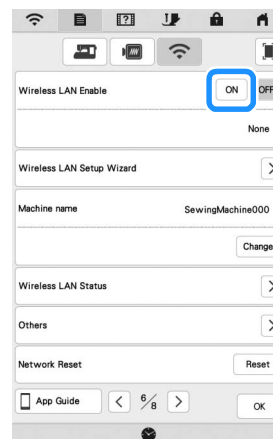

→ The machine begins to emit the wireless network signal.

## Using the Wizard to Set Up the Wireless Network Connection

There are multiple ways to set up the wireless network connection. We recommend the method that uses the wizard on this machine.

- 1 In order to connect your machine to a wireless network, the security information (SSID and network key) for your home network will be required. The network key may also be called a password, security key or encryption key. First, find your security information and note it.

SSID	Network Key (Password)

### Memo

- The wireless network connection cannot be set up if you do not have the security information.
- How to find the security information
  - ① Check the manual provided with your home network.
  - ② The default SSID may be the manufacturer's name or the model name.
  - ③ If you cannot find the security information, contact the manufacturer of the router, your network administrator or your Internet provider.
  - ④ Some SSIDs and network keys (passwords) are case (upper case and lower case) sensitive. Please properly record your information.

**2** Touch **>** beside [Wireless LAN Setup Wizard].

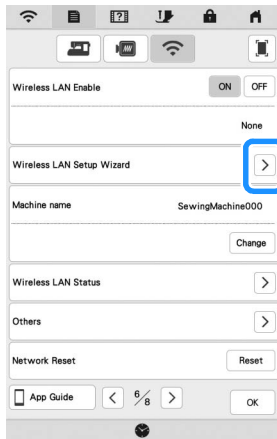

→ A list of available SSIDs appears.

**3** Touch **>** beside the SSID that was noted.

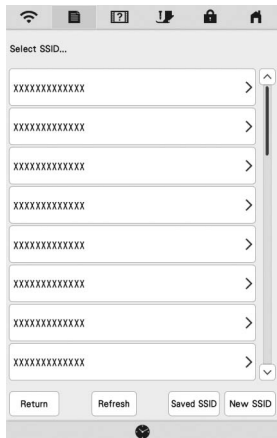

→ The screen for entering the network key (password) appears.

**Memo**

- If the SSID that was noted does not appear in the list, touch **Refresh**.
- If the desired network SSID is not displayed, specify it as described below.
  - ① Select **New SSID**.
  - ② Enter the desired network SSID, and then touch **OK**.
  - ③ Select the authentication method and encryption mode.
- If the machine had already been connected to the home network, touch **Saved SSID**, and then select the saved SSID.

**4** Enter the network key (password) that was noted, and then touch **OK**.

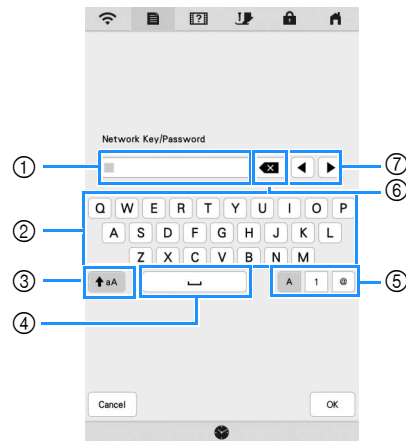

- ① Text input area
- ② Character keys
- ③ Caps key
- ④ Space key
- ⑤ Letters/numbers/symbols key
- ⑥ Backspace key (Deletes the character at the cursor's position.)
- ⑦ Cursor keys (Move the cursor to the left or right.)

**5** When the following message appears, touch **OK**.

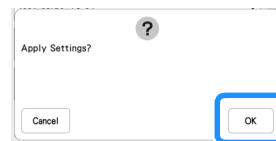

→ When a connection is established, the following message appears.

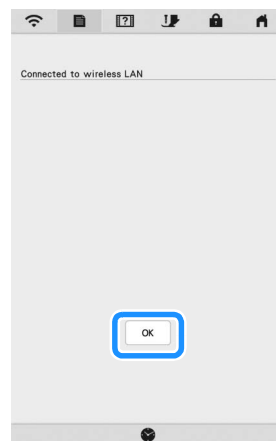

## 6 Touch **OK** to exit the setup.

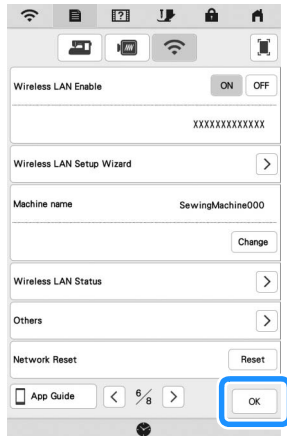

→ The name beside [Machine name] is the name that will be used when registering the machine with embroidery editing software (PE-DESIGN version 11 or later) or Design Database Transfer in order to transfer files.

### Memo

- While connected, the signal strength is indicated by the icon in the upper-left corner of the display.
- Once a wireless network connection has been set up, a connection will be established each time the machine is turned on. However, [Wireless LAN Enable] in the network settings screen must remain set to [ON].
- The name in the [Machine name] field will be used with the Artspira App (limited to certain sales region), My Stitch Monitor App and My Design Snap App.

## ■ Using the [Others] Menu to Set Up the Wireless Network Connection

The [Others] menu contains the following items.

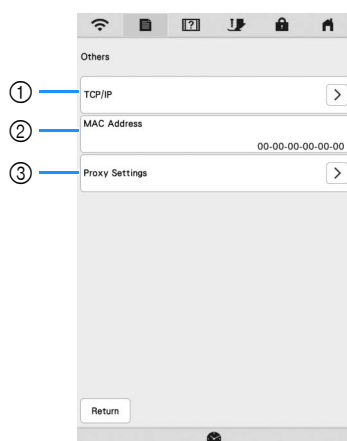

- ① TCP/IP settings can be manually entered.
- ② Shows the MAC address.
- ③ Use when proxy settings are required.

## CONNECTING THE ACCESSORY TO THE MACHINE

### Using a USB Mouse

A USB mouse, connected to the machine, can be used to perform a variety of operations in the screens. Connect a USB mouse to the USB port.

#### Memo

- Use a basic computer mouse to operate the machine functions. Some USB mouse devices may not be compatible with this machine.

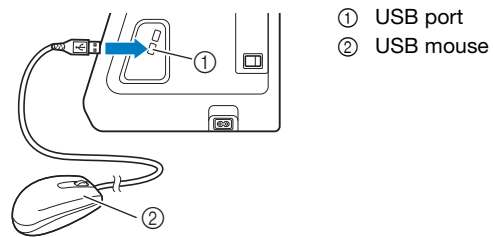

#### Note

- The left mouse button can be used to perform operations such as choosing a design and choosing menu keys.
- The mouse pointer does not appear in the screen saver or opening screen.

## ■ Clicking a Key

When the mouse is connected, the pointer appears on the screen. Move the mouse to position the pointer over the desired key, and then click the left mouse button.

#### Memo

- Double-clicking has no effect.

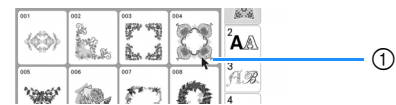

- ① Pointer

## WINDING/INSTALLING THE BOBBIN

### Winding the Bobbin

## IMPORTANT

- Use the plastic bobbins that came with this machine or bobbins of the same type: 11.5 mm (approx. 7/16 inch) plastic Class 15 (A style) bobbins, which are available from your Brother dealer.

### Using the Supplemental Spool Pin

With this machine, you can wind the bobbin during embroidering. While using the main spool pin for embroidery, you can conveniently wind the bobbin using the supplemental spool pin.

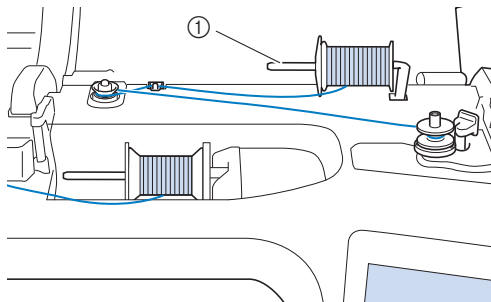

① Supplemental spool pin

**1** Turn the main power to ON and open the top cover.

**2** Align the groove in the bobbin with the spring on the bobbin winder shaft, and set the bobbin on the shaft.

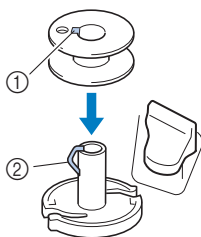

- ① Groove in the bobbin
- ② Spring on the bobbin winder shaft

**3** Place the spool of thread for the bobbin and the spool cap onto the supplemental spool pin.

Slide the spool onto the supplemental spool pin so that the thread unwinds to the front from the bottom. Otherwise the thread may become tangled around the supplemental spool pin.

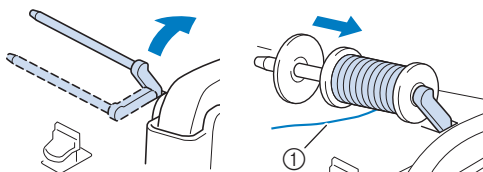

① The thread unwinds to the front from the bottom.

**4** Slide the spool cap onto the spool pin as far as possible to the right, with the rounded side on the left.

## IMPORTANT

- If the spool or the spool cap is not installed correctly, the thread may become tangled around the spool pin, and the machine may be damaged.
- Three spool cap sizes are available, allowing you to choose a spool cap that best fits the size of spool being used. If the spool cap is too small for the spool being used, the thread may catch on the slit in the spool or the machine may be damaged. When using mini king thread spool, use the thread spool insert. For details on thread spool insert (mini king thread spool), refer to "Note" on page 22.



### Note

- When using the spool as shown below, use the thread spool insert (mini king thread spool). Make sure that the thread spool insert is firmly inserted. After installing it, pull out some thread, and check that the thread unwinds without getting caught.

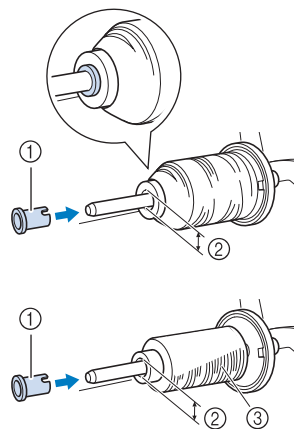

- ① Thread spool insert (mini king thread spool)
- ② Hole diameter 8.0 mm to 10.5 mm (approx. 5/16 inch to 13/32 inch)
- ③ Spool (cross-wound thread)



- 5** With your right hand, hold the thread near the thread spool. With your left hand, hold the end of the thread, and use both hands to pass the thread through the thread guide.

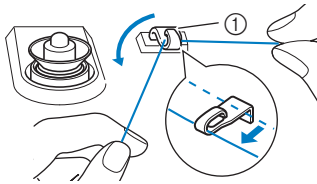

① Thread guide

- 6** Pass the thread around the pretension disk making sure that the thread is under the pretension disk.

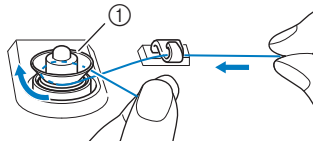

① Pretension disk

→ Make sure that the thread passes under the pretension disk.

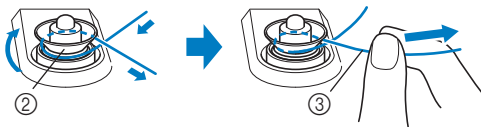

② Pretension disk

③ Pull it in as far as possible.

→ Check to make sure thread is securely set between pretension disks.

- 7** Wind the thread clockwise around the bobbin 5 or 6 times, pass the thread through the guide slit in the bobbin winder seat, and then pull the thread to cut it.

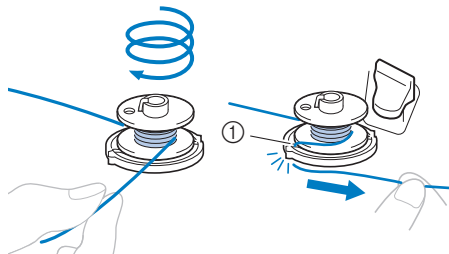

① Guide slit in bobbin winder seat (with built-in cutter)

#### Note

- Be sure to wind the thread clockwise around the bobbin, otherwise the thread may become wrapped around the bobbin winder shaft.

## CAUTION

- Be sure to cut the thread as described. If the bobbin is wound without cutting the thread using the cutter built into the guide slit in the bobbin winder seat, the thread may become tangled in the bobbin or the needle may break and cause injury when the bobbin thread starts to run out.

- 8** Set the bobbin winding switch to the left, until it clicks into place.

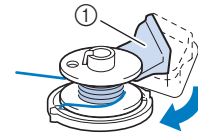

① Bobbin winding switch

→ The bobbin winding window appears.

- 9** Touch .

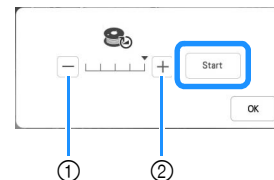

① Touch to decrease the winding speed.

② Touch to increase the winding speed.

→ Bobbin winding starts.  changes to  while the bobbin is winding. The bobbin stops rotating when bobbin winding is completed. The bobbin winding switch will automatically return to its original position.

#### Memo

- Touch  to minimize the bobbin winding window. Then, you can perform other operations, such as selecting a pattern or adjusting the thread tension, while the bobbin is being wound.
- Touch  (in top right of the LCD screen) to display the bobbin winding window again.



- The sound of winding the bobbin with stiff thread, such as metallic thread for quilting, may be different from the one produced when winding normal thread; however, this is not a sign of a malfunction.

- 10** After bobbin winding is finished, cut the thread with scissors and remove the bobbin.

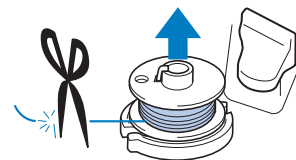

## IMPORTANT

- When removing the bobbin, do not pull on the bobbin winder seat. Doing so could loosen or remove the bobbin winder seat, and could result in damage to the machine.



**Using the Spool Pin**

You can use the main spool pin to wind the bobbin before embroidering. You cannot use this spool pin to wind the bobbin while embroidering.

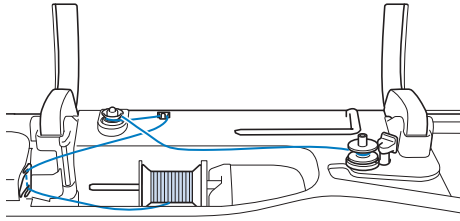

**1** Turn the main power to ON and open the top cover.

**2** Align the groove in the bobbin with the spring on the bobbin winder shaft, and set the bobbin on the shaft.

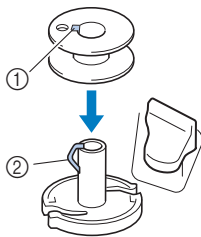

- ① Groove in the bobbin
- ② Spring on the bobbin winder shaft

**3** Remove the spool cap and place the spool of thread for the bobbin onto the spool pin.

Slide the spool onto the spool pin so that the thread unwinds to the front from the bottom.

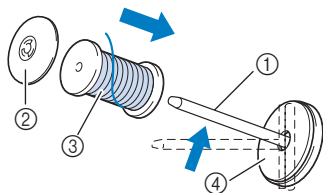

- ① Spool pin
- ② Spool cap
- ③ Spool of thread
- ④ Spool felt

**4** Slide the spool cap onto the spool pin as far as possible to the right, with the rounded side on the left.

**5** While holding the thread with both hands, pass the thread through grooves of the thread guide plate.

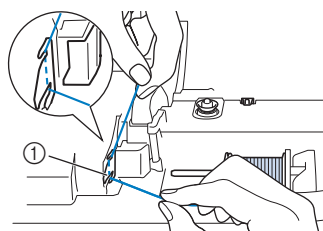

- ① Thread guide plate

**6** Pass the thread through the thread guide.

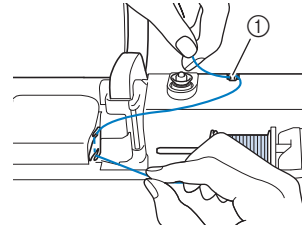

- ① Thread guide

**7** Pass the thread around the pretension disk making sure that the thread is under the pretension disk.

Pull the thread as far as possible.

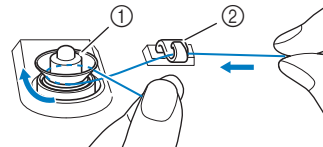

- ① Pretension disk
- ② Thread guide

**8** Follow steps 7 through 10 on page 23 through page 23.

## Setting the Bobbin

### ⚠ CAUTION

- Use a bobbin that has been correctly wound with thread, otherwise the thread tension may be incorrect and the needle may break, causing injuries.



- Before inserting or changing the bobbin, be sure to touch  in the LCD to lock all keys and buttons. Otherwise injuries may occur if the "Start/Stop" button or any other button is pressed and the machine starts embroidering.

- 1 Touch  to lock all keys and buttons and raise the presser foot.

- \* If the message [OK to automatically lower the presser foot?] appears on the LCD screen, touch  to continue.

- 2 Slide the bobbin cover latch to the right and remove the bobbin cover.

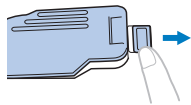

- 3 Insert the bobbin into the bobbin case so that the thread unwinds to the left.

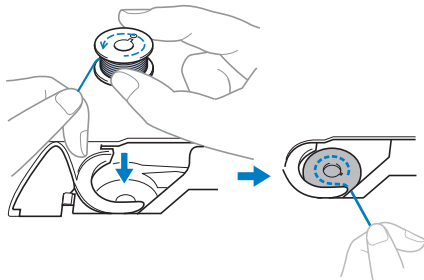

- 4 Lightly hold down the bobbin with your right hand, and then guide the end of the thread around the tab of the needle plate cover with your left hand.

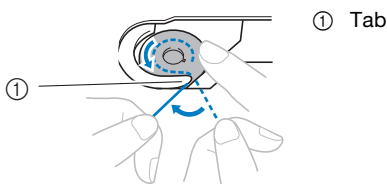

### 💡 Note

- Be sure to hold down the bobbin with your finger and unwind the bobbin thread correctly, otherwise the thread may break or the thread tension will be incorrect.

- 5 While lightly holding down the bobbin with your right hand, guide the thread through the slit in the needle plate cover and lightly pull it with your left hand.

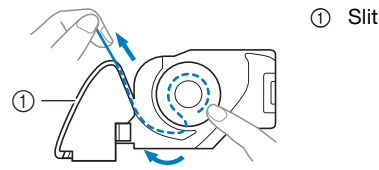

### 📌 Memo

- By pulling the thread in this way, the thread will enter the tension spring of the bobbin case to apply the appropriate tension to the bobbin thread during embroidery.

- 6 While lightly holding down the bobbin with your right hand, continue guiding the thread through the slit with your left hand. Then, cut the thread with the cutter.

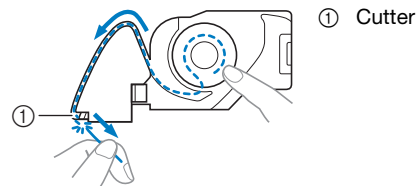

→ The cutter cuts the thread.

- 7 Reattach the bobbin cover.

Insert the tab of the bobbin cover into the notch of the needle plate cover, and then lightly press down on the right side.

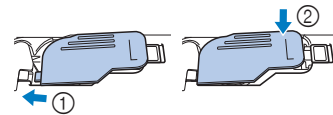

- 8 Touch  to unlock all keys and buttons.

## UPPER THREADING

### Upper Threading

#### ⚠ CAUTION

- Be sure to thread the machine properly. Improper threading can cause the thread to tangle and break the needle, leading to injury.

#### IMPORTANT

- When using 65/09 needle, manually thread the needle. If the automatic needle threading function is used, the unit may be damaged.

#### 📖 Memo

- The automatic threading function can be used with home sewing machine needle size 75/11.
- When threads such as metallic thread or specialty threads are used, it is not recommended to use the needle threader.
- For most embroidery applications, the upper thread should be 40-weight rayon or polyester embroidery thread.

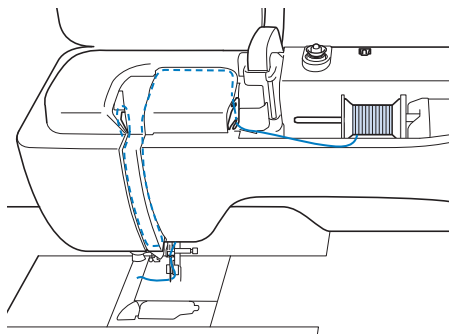

1 Turn the main power to ON.

2 Press  (Presser foot lifter button) to raise the presser foot.

→ The upper thread shutter opens so the machine can be threaded.

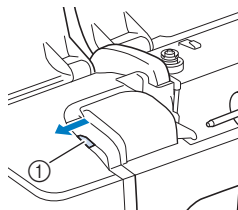

① Upper thread shutter

3 Press  (Needle position button) to raise the needle.

#### IMPORTANT

- Be sure to raise the needle before using the automatic needle threader. Otherwise, the needle may not thread correctly and the needle threader may be damaged.

4 Remove the spool cap and place the spool of thread onto the spool pin.

Slide the spool onto the spool pin so that the thread unwinds to the front from the bottom.

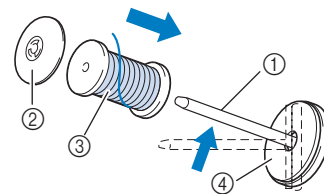

- ① Spool pin
- ② Spool cap
- ③ Spool of thread
- ④ Spool felt

5 Slide the spool cap onto the spool pin as far as possible to the right, with the rounded side on the left.

#### ⚠ CAUTION

- Choose a spool cap that best fits the size of spool being used. For more information, refer to "Note" on page 22.

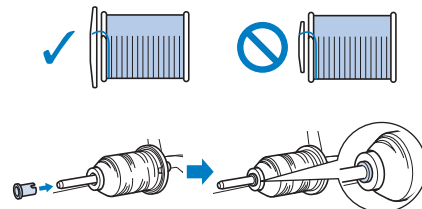

- If the spool or the spool cap is not positioned correctly, the thread may become tangled around the spool pin, possibly causing the needle to break, resulting in injuries.

**Note**

- When using thread that winds off quickly, such as metallic thread, place the spool net over the spool before placing the spool of thread onto the spool pin.
- If the spool net is too long, fold it to fit the size of the spool.

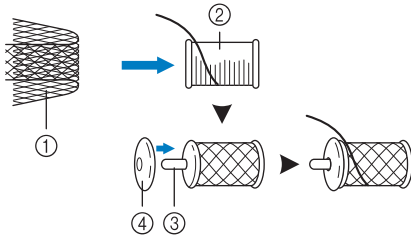

- ① Spool net
- ② Thread spool
- ③ Spool pin
- ④ Spool cap

\* When threading the spool with the spool net on, make sure that 5-6cm (approx. 2 - 2-1/2 inches) of thread is pulled out.

\* It may be necessary to adjust the thread tension when using the spool net.

- 6** While holding the thread with both hands, pass the thread through grooves of the thread guide plate.

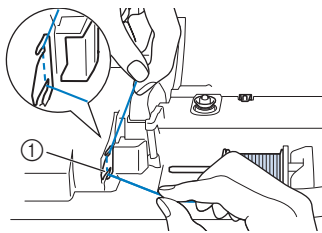

- ① Thread guide plate

- 7** While holding the thread in your right hand, pass the thread through the thread guide in the direction indicated.

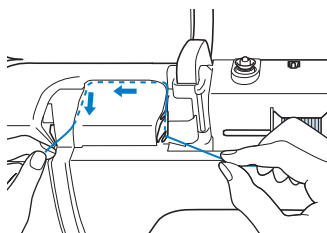

- 8** Guide the thread down, up, then down through the groove, as shown in the illustration.

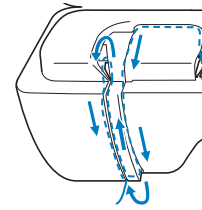
**Memo**

- Look in the upper groove area to check if the thread catches on the thread take-up lever visible inside the upper groove area.

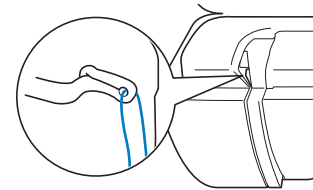

- 9** Pass the thread through the needle bar thread guide (marked "6") by holding the thread with both hands and guiding it as shown in the illustration.

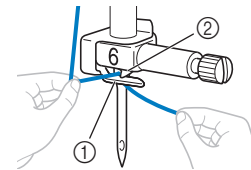

- ① Needle bar thread guide
- ② Tab

- 10** Pass the thread through the notch in the thread guide. Then firmly pull the thread from front to back into the slit of the thread guide disk (marked "7").

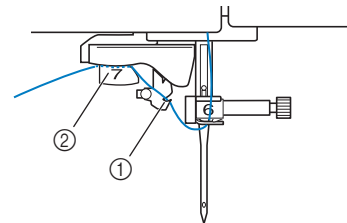

- ① Notch in thread guide
- ② Thread guide disk

- 11** Press  (Presser foot lifter button) to lower presser foot.

**12** Pull the thread up through the thread cutter to cut the thread, as shown in the illustration.

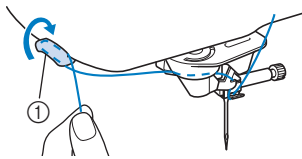

① Thread cutter

**Note**

- When using thread that quickly winds off the spool, such as metallic thread, it may be difficult to thread the needle if the thread is cut. Therefore, instead of using the thread cutter, pull out about 8 cm (approx. 3 inches) of thread after passing it through the thread guide disks (marked "7").

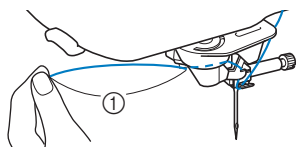



① About 8 cm (approx. 3 inches) or more

**13** Press  (Automatic threading button) to have the machine automatically thread the needle.

→ The thread passes through the eye of the needle.

**Memo**

- When  (Automatic threading button) is pressed, the presser foot will be automatically lowered. After threading is finished, the presser foot moves back to the position before  (Automatic threading button) was pressed.

**14** Carefully pull the end of the thread that was passed through the eye of the needle.

- \* If a loop was formed in the thread passed through the eye of the needle, carefully pull on the loop of thread through to the back of the needle.

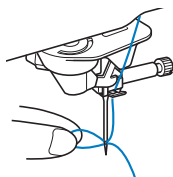

**15** Raise the presser foot lever and pull out about 10 cm (approx. 4 inches) of the thread, and then pass it under the presser foot toward the rear of the machine.

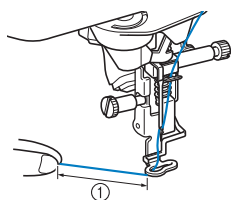

① About 10 cm (approx. 4 inches)

**Memo**

- If the needle could not be threaded or the thread was not passed through the needle bar thread guides, perform the procedure again starting from step 3.

**Note**

- Some needles and threads cannot be threaded with the needle threader. In this case, instead of using the needle threader after passing the thread through the needle bar thread guide (marked "6"), manually pass the thread through the eye of the needle from the front.

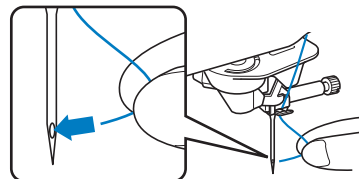

**Using the Vertical Spool Pin**

Use the vertical spool pin when using an irregularly shaped thread spool, and when embroidering with metallic thread.

**1** Insert the vertical spool pin onto the bobbin winder shaft.

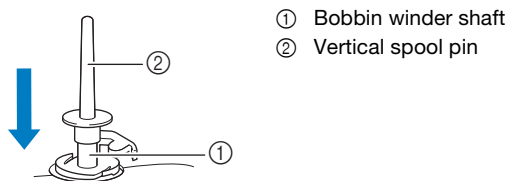

① Bobbin winder shaft  
② Vertical spool pin

**2** Install the spool felt and the thread spool in that order, and then thread the upper thread.

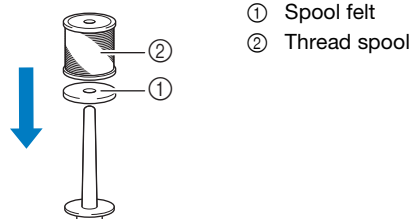



① Spool felt  
② Thread spool

**Memo**

- When setting the thread spool, set it so that the thread winds off from the front of the spool.
- This method keeps the thread from twisting as it comes off the spool pin.

## CHANGING THE NEEDLE

**⚠ CAUTION**

- Always touch  on the screen to lock all keys and buttons before changing the needle. If  is not touched and the “Start/Stop” button or another operation button is pressed accidentally, the machine will start and injury may result.
- Use only home sewing machine needles. Other needles may break and may cause injury.
- Never use a bent needle. This may cause injury.

**■ Thread and Needle Number**

The lower the thread number is, the heavier the thread; the higher the needle number, the larger the needle.

**■ Embroidery Needles**

Use a ball point needle 75/11.

 **Memo**

- To check the needle correctly, place the flat side of the needle on a flat surface. Check the needle from the top and the sides. Throw away any bent needles.

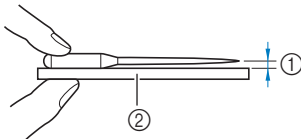

- ① Parallel space
- ② Flat surface (bobbin cover, glass, etc.)

- The machine needles are consumables. Replace the needle in cases such as those described below.
  - If an unusual sound is produced when the needle enters the fabric. (The tip of the needle may be broken or dull.)
  - If stitches are skipped. (The needle may be bent.)

**1** Press  (Needle position button) to raise the needle.

**2** Touch  to lock all keys and buttons.

- \* If the message [OK to automatically lower the presser foot?] appears on the LCD screen, touch  to continue.

 **Note**

- Before replacing the needle, cover the hole in the needle plate with fabric or paper to prevent the needle from falling into the machine.

**3** Remove the presser foot. (page 111)

**4** Use the disc-shaped screwdriver to turn the needle clamp screw toward you (counterclockwise) to loosen the screw. Remove the needle.

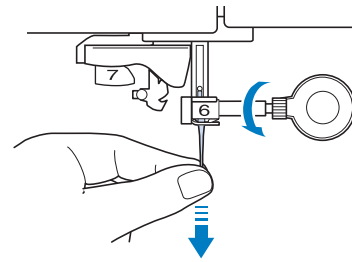

**5** With the flat side of the needle facing the back, insert the new needle all the way to the top of the needle stopper (viewing window) in the needle clamp. Use the disc-shaped screwdriver to securely tighten the needle clamp screw.

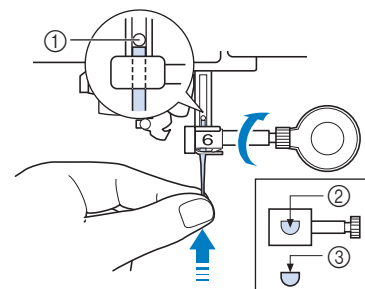

- ① Needle stopper
- ② Hole for inserting the needle
- ③ Flat side of the needle

**⚠ CAUTION**

- Be sure to push in the needle until it touches the stopper, and securely tighten the needle clamp screw with the disc-shaped screwdriver. If the needle is not completely inserted or the needle clamp screw is loose, the needle may break and cause injury.

**6** Attach the presser foot. (page 111)

**7** Touch  to unlock all keys and buttons.





# Chapter 2 BASIC EMBROIDERY

## BEFORE EMBROIDERING

### Embroidery Step by Step

Follow the steps below to prepare the machine for embroidery.

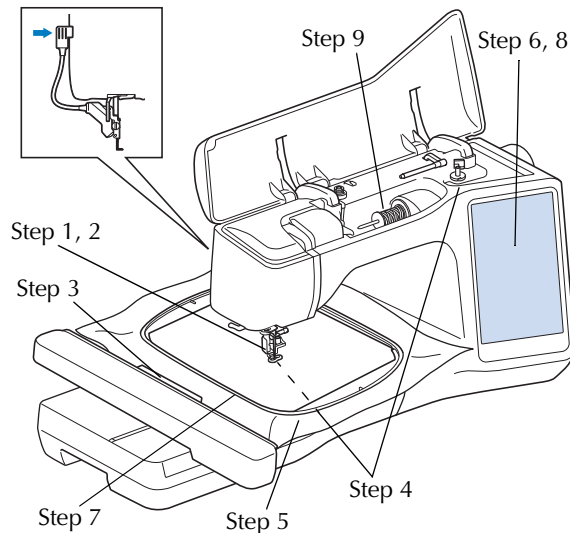

Step #	Aim	Action	Page
1	Presser foot attachment	Attach embroidery foot "W+" with LED pointer.	111
2	Checking the needle	Use needle 75/11 for embroidery.	29
3	Embroidery unit attachment	Attach the embroidery unit.	31
4	Bobbin thread setup	For the bobbin thread, wind embroidery bobbin thread and set it in place.	22
5	Fabric preparation	Attach a stabilizer material to the fabric, and hoop it in the embroidery frame.	53
6	Pattern selection	Turn the main power to ON, and select an embroidery pattern.	33
7	Embroidery frame attachment	Attach the embroidery frame to the embroidery unit.	56
8	Checking the layout	Check and adjust the size and position of the embroidery.	57
9	Embroidery upper thread setup	Set up embroidery upper thread according to the pattern.	26

### About the Embroidery Unit

## ⚠ CAUTION

- Do not move the machine with the embroidery unit attached. The embroidery unit could fall off and cause injury.

## IMPORTANT

- Keep your hands and foreign objects away from the embroidery carriage and frame when the machine is embroidering. Damage or malfunction may result.
- Be sure to turn off the power before attaching or removing the embroidery unit. Otherwise, the machine may be damaged.
- Do not touch the inner connector of the embroidery unit. The pins on the embroidery unit connection may be damaged.
- Do not apply strong force to the embroidery unit carriage or pick up the unit by the carriage. Otherwise, the embroidery unit may be damaged.
- Do not push on the carriage when attaching the embroidery unit onto the machine. Moving the carriage may damage the embroidery unit.
- Make sure that there is enough space for the carriage of the embroidery unit to move. If the embroidery frame comes into contact with an object, the pattern may not be embroidered correctly, or damage may result.
- Do not touch the embroidery carriage until the initialization finishes.

### 💡 Note

- To avoid distorting your embroidery design, do not touch the embroidery carriage and frame when the machine is embroidering.
- Store the embroidery unit in a safe place to prevent damage to the unit.

### ■ Attaching the Embroidery Unit

- 1 Turn the main power to OFF.
- 2 Insert the embroidery unit connection into the connection port of the machine until it snaps into place.

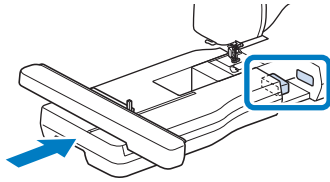

**Note**

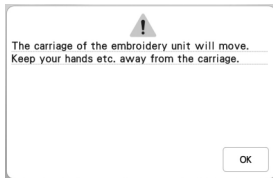

- Be sure there is no gap between the embroidery unit and the machine. If there is a gap, the embroidery patterns will not embroider with the correct registration.

- 3 Turn the main power to ON.  
→ The following message will appear.



- 4 Touch  .  
→ The carriage will move to the initialization position.

### ■ Removing the Embroidery Unit

- 1 Remove the embroidery frame.
  - For details on removing the embroidery frame, refer to "Removing the Embroidery Frame" on page 57.
- 2 Touch , then touch  .  
→ The carriage will move to the removal position.
- 3 Turn the main power to OFF.
- 4 Press the release button, and pull the embroidery unit away from the machine.

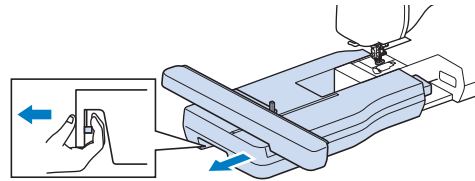

## SELECTING PATTERNS

### ■ Copyright Information

The patterns stored in the machine and patterns sold separately are intended for private use only. Any public or commercial use of copyrighted patterns is an infringement of copyright law and is strictly prohibited.

### ■ About Embroidery Patterns

There are many character and decorative embroidery patterns stored in the machine's memory (see the "Embroidery Design Guide" for a full summary of patterns in the machine's memory or visit <https://s.brother/cmekb/>). You can also use patterns sold separately.

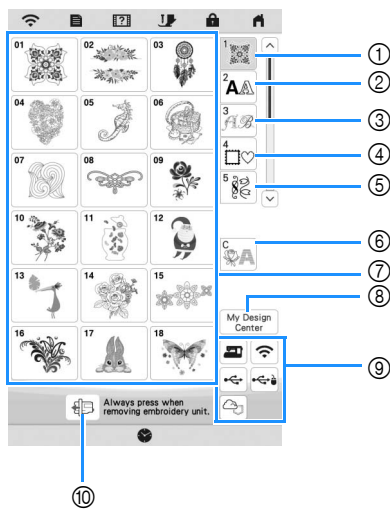

- ① Embroidery patterns
- ② Character patterns
- ③ Decorative alphabet patterns
- ④ Frame patterns
- ⑤ Utility embroidery patterns
- ⑥ Couching patterns (page 84)
- ⑦ Pattern type selection keys
- ⑧ My Design Center (page 89)
- ⑨ Patterns saved in the machine's memory, USB media, etc. (page 82)
- ⑩ Touch this key to position the embroidery unit for storage.

## Selecting Embroidery Patterns

- 1 Touch the category tab and then touch the pattern type selection key or pattern key you want to embroider.

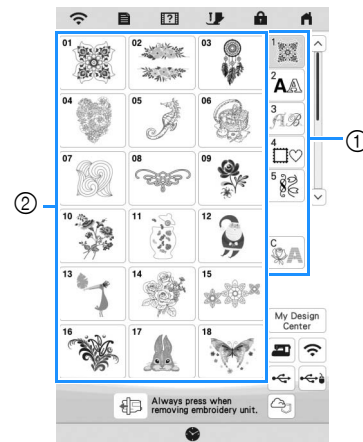

- ① Pattern category tab
- ② Pattern type/pattern selection key

- 2 Select a pattern.

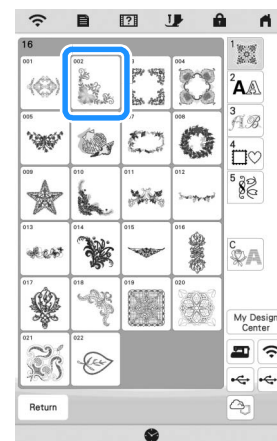

- \* Touch the category tab or Return to return to the previous screen.
- The selected pattern is displayed.

**3** Touch **Set** to set the pattern.

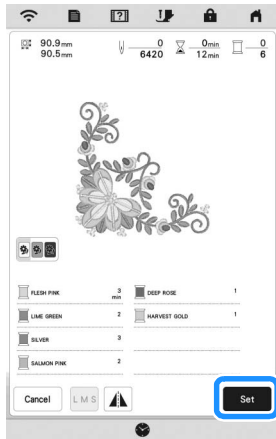

\* Touch  to darken the background color for the pattern image with bright thread colors, to get a clearer image.

→ The pattern is designated with a red box around it on the edit screen.

**4** Touch **Edit** to edit the selected pattern. (page 39)

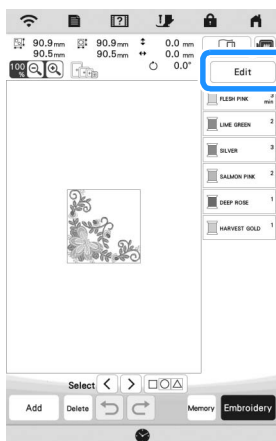

**5** Touch **Embroidery**.  
→ The embroidery screen appears.

**6** Touch **Layout** to edit the pattern before embroidering. (page 51)

\* To return to the edit screen, touch **Return**.

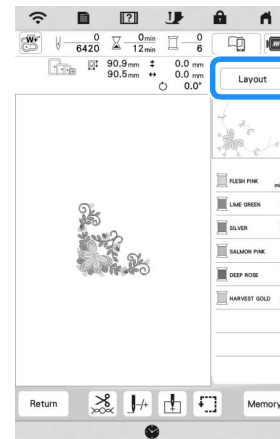

**7** Start embroidering. (page 65)

## Selecting Character Patterns

1 Touch **A**.

2 Touch the key of the font you want to embroider.

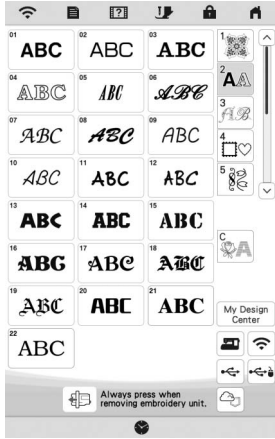

- \* : View the next page.
- : View the previous page.

3 Select the character category and then type in the text. (page 35)



4 Touch **Set**.  
→ The edit screen appears.

5 Follow the steps from 4 to 7 of "Selecting Embroidery Patterns" on page 33.

## Character Pattern Input Keys

### Memo

- If a key display is grayed out, you cannot use that function with the selected pattern.

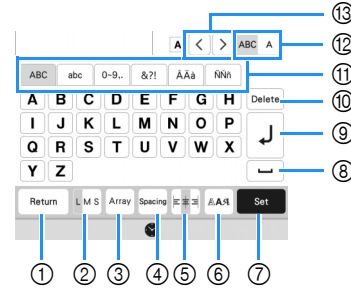

No.	Display	Explanation
	Name	
①		Return to the previous screen.
	Return key	
②		Change the size of the character patterns. To change the size of one character, touch  to display  and then select the character. The size of the selected character is changed.
	Size key	
③		Change the configuration of the character patterns. <ul style="list-style-type: none"> <li>• To arrange the character patterns on an arc, touch .</li> <li> : Make the arc flatter.</li> <li> : Make the arc rounder.</li> <li>• To arrange the character patterns on an incline, touch .</li> <li> : Change the incline counterclockwise.</li> <li> : Change the incline clockwise.</li> <li>•  : Reset the layout.</li> </ul>
	Array key	
④		Change the spacing of the character patterns. <ul style="list-style-type: none"> <li>•  : Increase the character spacing.</li> <li>•  : Decrease the character spacing.</li> <li>• To change the spacing after one character, touch  to display  and then select the character. The spacing between the selected character and the next character is changed.                             <div style="display: flex; justify-content: space-around; align-items: center; margin-top: 5px;"> <div style="text-align: center;"> <b>ABCD E</b> ↔ <b>ABCDE</b> </div> <div style="text-align: center;"> <b>A B C D E</b> ↔ <b>ABCDE</b> </div> </div> </li> <li>•  : Move the one selected character up.</li> <li>•  : Move the one selected character down.</li> <li>•  : Reset the spacing.</li> </ul>
	Character spacing key	

No.	Display	Explanation
	Name	
⑤		Switch alignment. This function is available when multiple lines of characters are input. <ul style="list-style-type: none"> <li> : Right alignment</li> </ul> <p style="text-align: right;">ABCDE FGH IJKLMNOP</p> <ul style="list-style-type: none"> <li> : Left alignment</li> </ul> <p style="text-align: left;">ABCDE FGH IJKLMNOP</p> <ul style="list-style-type: none"> <li> : Center alignment</li> </ul> <p style="text-align: center;">ABCDE FGH IJKLMNOP</p>
	Alignment key	
⑥		Change the font of the characters. Depending on the font that was selected, it may not be possible to change the font. <ul style="list-style-type: none"> <li>To change the font of one character, touch  to display  and then select the character. The font of the selected character is changed.</li> </ul>
	Font Type key	
⑦		Apply the character pattern editing.
	Set key	
⑧		Enter a space.
	Space key	
⑨		Make a new line.
	Line feed key	
⑩		Delete the character.
	Delete key	
⑪	-	Select the category of character.
	Category keys	
⑫		Select to edit all characters or one character. <ul style="list-style-type: none"> <li> : Edit all characters.</li> <li> : Edit one character.</li> </ul>
	Select one/all key	
⑬		Move the cursor and select a character.
	Character selection keys	

## Selecting Frame Patterns

1 Touch .

2 Touch the key of the frame shape you want to embroider in the top part of the screen.

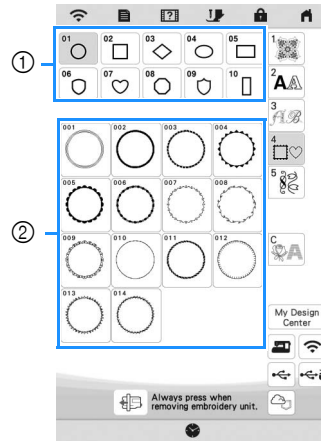

- ① Frame shapes
- ② Frame patterns

→ Various frame patterns are displayed at the bottom part of the screen.

3 Touch the key of the frame pattern you want to embroider.

→ The selected pattern is displayed on the screen.

4 Touch .

→ The edit screen appears.

5 Follow the steps from 4 to 7 of “Selecting Embroidery Patterns” on page 33.

## Combining Patterns

Example:



1 Select a pattern and then touch **Set**.

2 Touch **Add**.

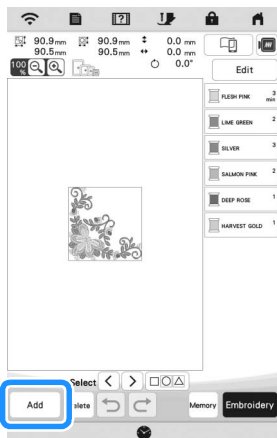

3 Touch **A**.

4 Select **ABC** and enter "LOVE".

→ The characters you enter will be displayed in the center of the embroidery pattern area.

5 Touch **Set**.

6 Touch **Edit** and then touch **Move**.

7 Use  to move the characters.

\* Characters can also be moved by directly dragging them with your finger or the touch pen.

8 Touch **OK**.

9 Touch  to change the color of the characters. (page 48)

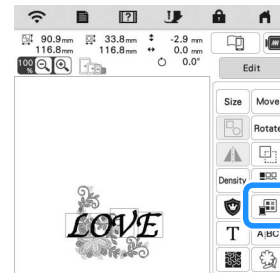

10 Touch **OK**.



11 When all editing is finished, touch **Embroider**.

### Memo

- Combined patterns will be embroidered in the order they were entered.

### ■ Selecting a Pattern

If multiple patterns have been combined, use

**Select**   to select the pattern to be edited. Patterns can also be selected by directly touching the screen with your finger or touch pen.

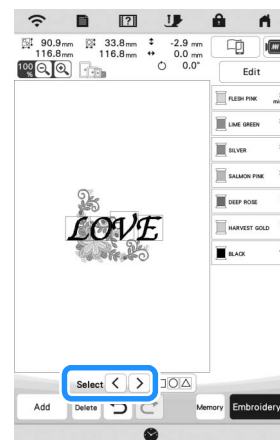

**■ Selecting Multiple Patterns at the Same Time**





Multiple patterns can easily be edited, for example, when moving patterns, if they are all selected together.

1 Touch .

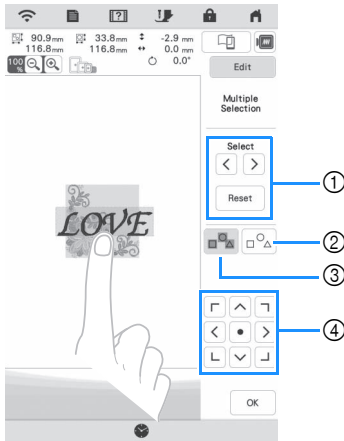

2 Touch each pattern to be selected.



- ① Touch  or  to check the patterns to be selected, and then touch . The selected patterns are highlighted with a red box. To deselect the selected patterns, touch .
- ② Touch this key to deselect all selected patterns.
- ③ Touch this key to select all patterns in the pattern display area.
- ④ Patterns can be moved with this key.

 **Memo**

- You can also select multiple patterns by dragging your finger to specify the area of selection.

3 Touch  to return to the edit screen.

→ Each selected pattern is surrounded with a red box.

 **Memo**

- The following functions are available while multiple patterns are selected.
  - Moving
  - Copying
  - Grouping
  - Stippling
  - Extracting pattern outlines

**■ Grouping Patterns**

If the multiple patterns are grouped, they can be edited as a single pattern.

1 Select patterns you want to group. (page 38)

2 Touch .

→ The selected patterns are grouped.

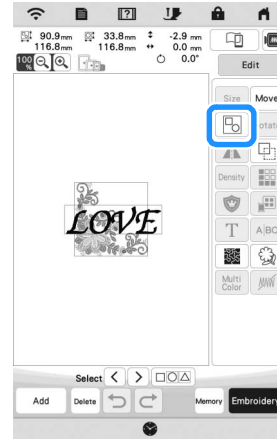

- \* To ungroup a grouped pattern, select the grouped pattern, and then touch . At this time, multiple patterns are selected. To cancel the multiple selection, touch any other pattern or the blank area.

 **Memo**

- The following functions are applied to all patterns in the grouped pattern.
  - Moving
  - Rotating
  - Appliqué
  - Border
  - Extracting pattern outlines
  - Simple stippling
  - Thread color changing



# EDITING PATTERNS

Using these keys, you can edit the pattern as you like.

## Memo

- If a key display is grayed out, you cannot use that function with the selected pattern.

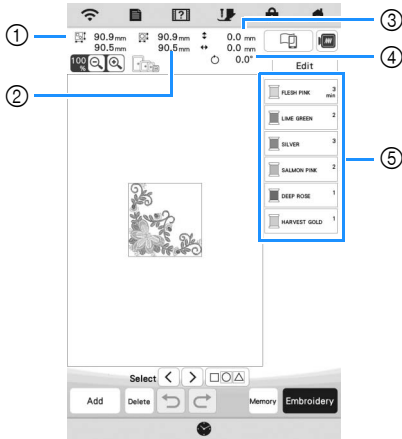







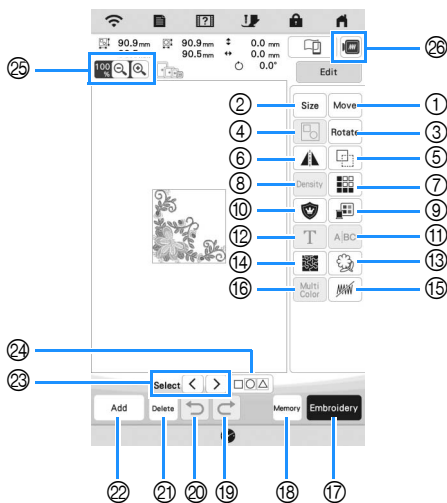







- ① Size of the entire combined pattern
- ② Size of the pattern currently selected
- ③ Distance from the center of the frame to the center of the pattern currently selected
- ④ Degree of rotation for the pattern currently selected
- ⑤ Color sequence and stitching times of each step of the pattern

## Key Functions

Touch  to display the editing window.



No.	Display Name	Explanation	Page
①	Move	Display the pattern moving window.	37
	Move key	 <ul style="list-style-type: none"> <li>•  : Move the pattern in the direction shown by the arrow.</li> <li>•  : Center the pattern.</li> </ul>	

No.	Display Name	Explanation	Page
②	Size	Display the pattern sizing window.	42
	Size key	<ul style="list-style-type: none"> <li>•  : Decrease the pattern proportionately.</li> <li>•  : Decrease the pattern vertically.</li> <li>•  : Decrease the pattern horizontally.</li> <li>•  : Enlarge the pattern proportionately.</li> <li>•  : Stretch the pattern vertically.</li> <li>•  : Stretch the pattern horizontally.</li> <li>•  : Change the size of the character patterns.</li> <li>•  : Reset the size. (except for character patterns.)</li> <li>•  : Move the pattern in the direction shown by the arrow.</li> </ul>	
③	Rotate	Display the pattern rotating window.	—
	Rotate key	<ul style="list-style-type: none"> <li>•  : Reset the position.</li> <li>•  : Move the pattern in the direction shown by the arrow.</li> </ul> <p>You can also rotate the pattern by dragging the red point at the corners of the pattern.</p>	
④	Group key	Group selected multiple patterns.	38
⑤	Duplicate key	Duplicate the pattern.	—
⑥	Horizontal mirror image key	Change the pattern to a horizontal mirror image.	—
⑦	Border key	Make and edit the repeated pattern.	42
⑧	Density key	Allows the thread density to change for some Alphabet characters and frame patterns. Other patterns density can be modified after the pattern size is changed.	41
⑨	Thread palette key	Change the thread color.	49
⑩	Appliqué key	Create an appliqué outline of the pattern.	72

No.	Display	Explanation	Page
	Name		
11		Separate the continuous character patterns to adjust the spacing or edit separately afterwards. <ul style="list-style-type: none"> <li>  : Select where the patterns is to be separated.</li> <li> : Separate the patten. A separated character pattern cannot be combined again.</li> </ul>	—
	Separate key		
12		Edit character patterns.	35, 40
	Letter Edit key		
13		Extract the outline of the pattern. The extracted pattern can be used with My Design Center.	104
	Outline key		
14		Touch this key to create stippling, echo quilting, or decorative fill around a pattern.	87
	Stippling key		
15		Touch this key to specify not to embroider the selected thread color.	46
	Deselect region setting (no sew setting) key		
16		Touch this key when you want to change the thread color, character by character in character embroidery. Since the machine stops at the end of each character, the upper thread can be changed as you embroider.	—
	Multi color key		
17		Proceed to the embroidery screen.	—
	Embroidery key		
18		Save a pattern in the machine's memory or USB media. The pattern can also be transferred to a computer via a wireless network connection.	81
	Memory key		
19		Redo the last operation that was undone.	—
	Redo key		
20		Undo the last operation.	—
	Undo key		
21		Delete the selected pattern (the pattern outlined by the red box).	—
	Delete key		
22		Add another pattern to the editing pattern.	37
	Add key		
23		Select the pattern to edit when there are multiple patterns.	37
	Pattern select key		
24		Make multiple patterns to be selected at the same time.	38
	Multiple selection key		

No.	Display	Explanation	Page
	Name		
25		<ul style="list-style-type: none"> <li> : Magnify the image.</li> <li>Use  /  /  /  to scroll through the display in any direction.</li> <li> : Demagnify the image (minimum: 100%).</li> <li> : Select the percent of magnification.</li> </ul>	—
	Magnify keys		
26		Preview the embroidered image.	41
	Image key		

■ Editing Letters

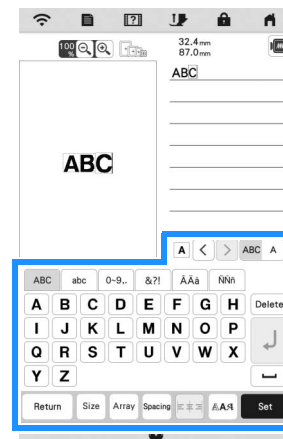

For details on input keys, refer to “Character Pattern Input Keys” on page 35.

**Memo**

- To edit character patterns with multiple lines in the edit screen, ungroup the pattern. (page 38)

## Previewing the Pattern

1 Touch .

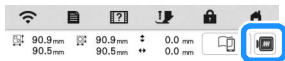

→ An image of the pattern as it will be embroidered appears.

2 Touch  to select the frame used in the preview.

- \* Frames displayed in gray cannot be selected.
- \* Touch  to enlarge the image of the pattern.
- \* The pattern can be embroidered as it appears in the display.





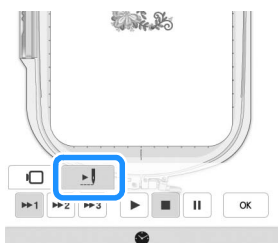

3 Touch  to check the embroidering order.

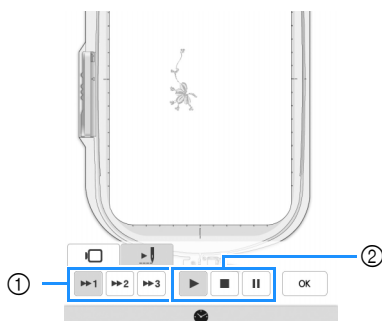

→ The stitch simulator screen appears.



- ① Simulation speed keys
  -  : Start the simulation at the set speed.
  -  : Pause the simulation.
  -  : Stop the simulation.
- ② Operation keys

- \* Touch  to return to the embroidery frame selection screen.

4 Touch .

## Changing the Size and the Density of the Pattern

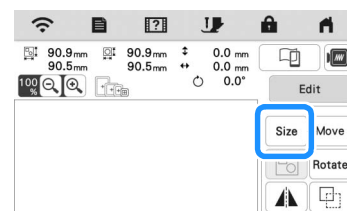

If  is selected, you can change the pattern size while maintaining the thread density. The machine recalculates the stitch density automatically. With this function, the pattern will be enlarged or reduced at a larger ratio than with normal pattern resizing.

1 Touch , and then touch .

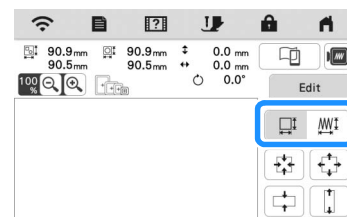

2 Select  in the size window.



- \*  : Change the pattern size while maintaining the number of stitches. Enlarged patterns will be less dense, and reduced patterns will be more dense. In order to maintain embroidering quality, there is a limit to how much the embroidery pattern can be enlarged or reduced.
- \*  : Change the pattern size while maintaining the thread density. After the pattern size is changed, the thread density can be changed in the edit screen. The number of stitches is recalculated depending on the pattern size.

### Memo

- This function cannot be used with alphabet character patterns, frame patterns, repeated patterns or buttonhole patterns.
- Patterns with a large number of stitches (100,001 or more) cannot be resized while maintaining a thread density.
- You can also change the size by dragging the red point at the sides and corners of the pattern.

**3** Select the direction in which to change the pattern size.

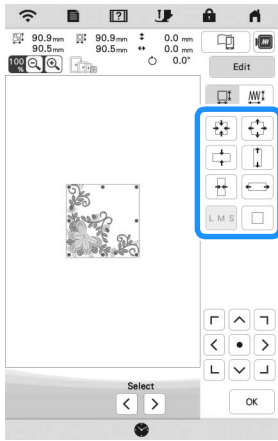

**4** When you select in step **2**, touch , and then touch to change the thread density.

- \* : Make the pattern less dense.
- \* : Make the pattern more dense.

**5** Touch .

### Creating Repeated Patterns

Using the border function, you can create repeated patterns. You can also adjust the spacing of the patterns.

**1** Touch , and then touch .

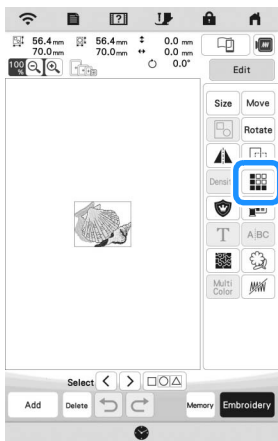

**2** Select the direction in which the pattern will be repeated.

- \* : Repeat the pattern above.
- \* : Repeat the pattern below.
- \* : Delete above pattern.
- \* : Delete below pattern.

Vertical direction

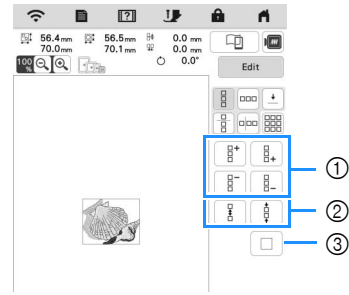

- ① Repeating and deleting keys
- ② Spacing keys
- ③ Key to cancel pattern repeating

Horizontal direction

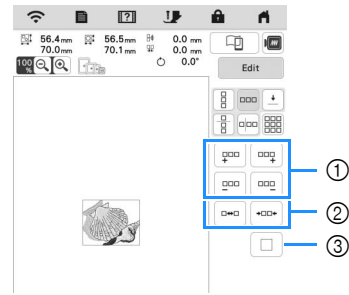

- ① Repeating and deleting keys
- ② Spacing keys
- ③ Key to cancel pattern repeating

**3** Adjust the spacing of the repeated pattern.

- \* : Widen spacing.
- \* : Tighten spacing.

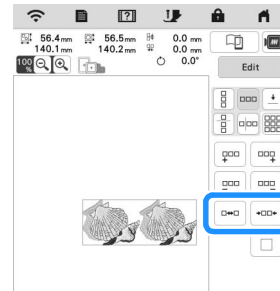

**4** Complete repeated patterns by repeating steps **2** through **3** .

**5** Touch .

### ■ Repeating Patterns Using the Matrix Copy

Place the pattern repeatedly throughout the embroidery area.

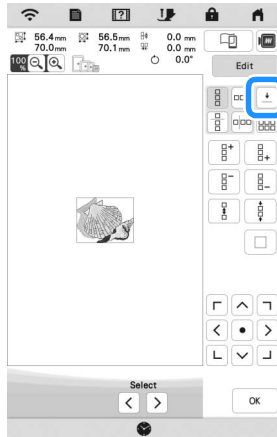

1 Touch .

2 Touch .



→ The repeated pattern is displayed positioned throughout the area.

3 Adjust the spacing of the repeated pattern.

\*    : Widen spacing.

\*    : Tighten spacing.

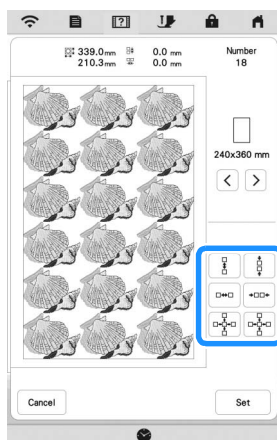

→ Every time the key is pressed, the pattern is automatically re-laid out.

4 Touch .

5 Touch .

### ■ Repeating One Element of a Repeated Pattern

You can select one element of a repeated pattern and repeat only that single element. This function allows you to create complex repeated patterns.

1 Touch .

2 Choose the direction in which the repeated pattern will be cut.

\*  : Cut horizontally.

\*  : Cut vertically.

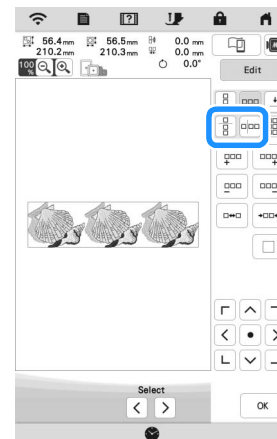

→ The pattern direction indicator will change depending on the direction selected.

3 Use  and  to select the cut line.

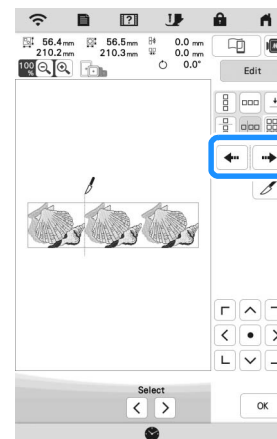

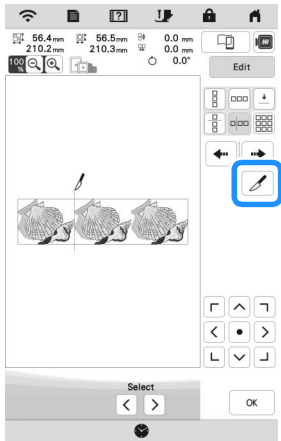

4 Touch  .



→ The repeated pattern will be divided into separate elements.

5 Touch  .

6 Use  and  to select the element to repeat.

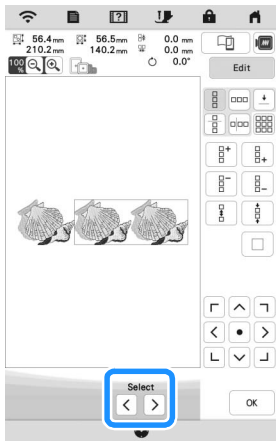

7 Repeat the selected element.

8 Touch  .

■ **Color Sorting Repeated Patterns**

Touch  to automatically change the embroidering order of colors in combined border embroidery patterns so that the same color can be continuously embroidered. This allows you to continue embroidering without repeatedly changing the upper thread or changing the embroidering order manually.

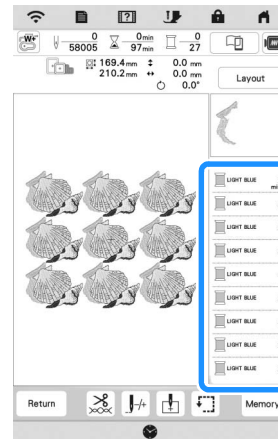
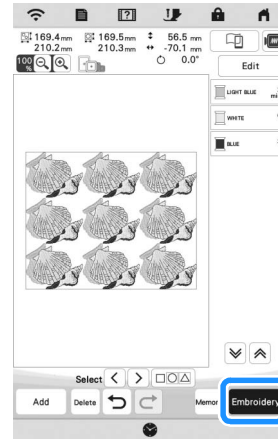

 **Memo**

- When a grouped pattern is repeated, the embroidering order is changed in each pattern.
- If there are repeated patterns with other repeated patterns or other patterns, the embroidering order of only the repeated patterns is changed.

### ■ Assigning Thread Marks

By sewing thread marks, you can easily align patterns when rehooping the fabric to embroider a series. When embroidering is finished on a pattern, a thread mark in the shape of an arrow will be sewn using the final thread. When embroidering a series of patterns, use the point of this arrow for positioning the following designs to be embroidered.

1 Touch .

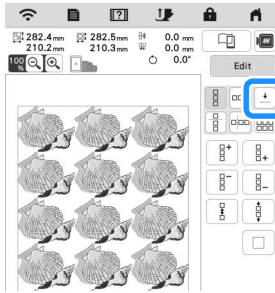

2 Touch .

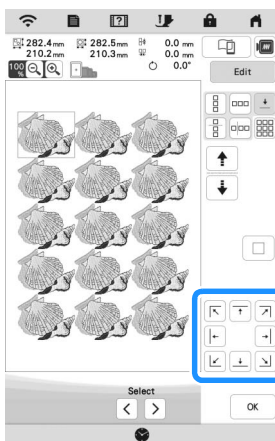

3 Touch  to select the thread mark to be sewn.



#### Memo

- When there are two or more elements, use  or  to select an element to assign a thread mark(s) to.

4 Touch .

### Embroidering the Pattern Repeatedly

After creating the repeated pattern, rehoop the embroidery frame and keep embroidering for the next pattern.

1 Select the repeated pattern and assign the thread mark at the center of the bottom of the pattern.

\* Refer to “Assigning Thread Marks” on page 45.

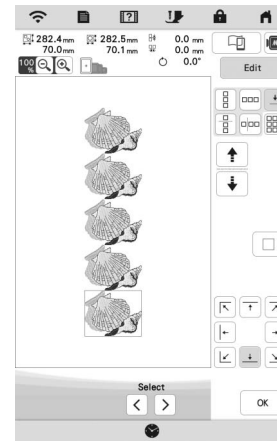

2 Touch , then .

3 Press the “Start/Stop” button to start embroidering.

→ When embroidering is finished, the thread mark is embroidered with the last thread color.

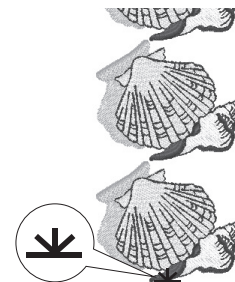

4 Remove the embroidery frame.



**5** Rehoop the fabric in the embroidery frame.

**Note**

- Adjust the position of the fabric so that the embroidering area for the next pattern is within the embroidering area.

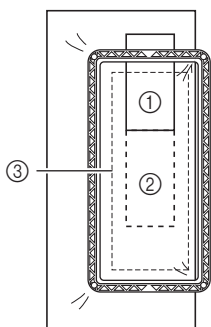

- ① Pattern embroidered first
- ② Position of pattern to be embroidered next
- ③ Embroidering area

**6** Attach the embroidery frame to the machine, and then

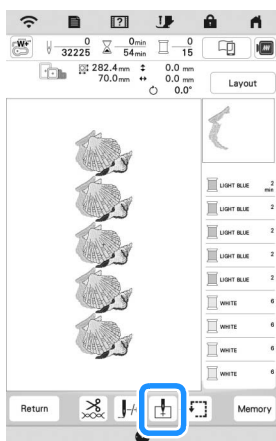

touch .



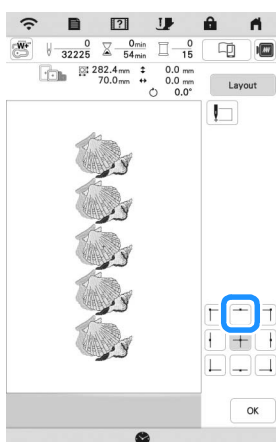

**7** Touch  to set the starting point to the center top of the pattern.

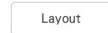

**8** Touch .

**9** Touch , and then touch .

**10** Touch  to move the embroidery frame until the thread mark on the fabric is aligned with the light of the LED pointer.

\* To check the needle drop point with the light of the LED pointer, touch .

**Memo**

- For the accurate needle drop point, slowly turn the handwheel toward you (counterclockwise) to lower the needle. Then, turn the handwheel away from you (clockwise) until the mark on the handwheel is at the top. The carriage cannot move if the mark on the handwheel is not at the top.

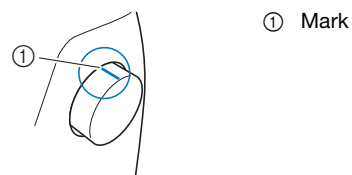

**11** Touch .

**12** Remove the thread mark.

**13** Start embroidering.

**Deselect Region Setting (No Sew Setting)**

The deselect region setting (which specifies that a thread color will not be embroidered) can be applied to a part of the pattern with a specific color.

**1** Touch  in the embroidering edit screen.

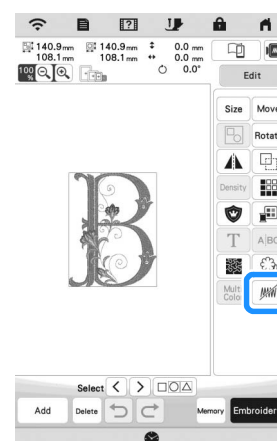

- From the thread color sequence display, select the thread color that will not be embroidered.

→ The selected thread color is highlighted in blue.

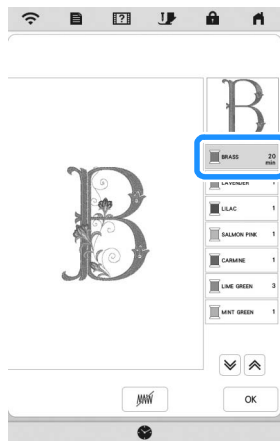

- Touch .

→ The mark  appears to indicate that the selected thread color will not be embroidered. The parts of the pattern that will not be embroidered are hidden in the pattern preview screen.

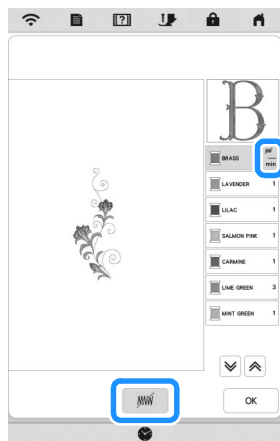



 **Memo**

- To cancel the setting, select the thread color and touch .

- If necessary, repeat steps 2 and 3 for all thread colors that will not be embroidered.

- After specifying the desired settings, touch .

- Touch  and then touch  to check an enlarged image of the finished embroidery.

\* After deselecting a region, check the image to be sure no previously hidden stitches are visible.



 **Memo**

- When a pattern with the deselect region setting applied is saved, the deselect region setting is also saved. However, the pattern cannot be saved if the deselect region setting is applied to all thread colors.
- The parts with the deselect region setting applied are merely not displayed; they are not deleted. The embroidery area required to embroider the pattern is the same as for the original pattern.



# EDITING COLORS

## Changing the Thread Color

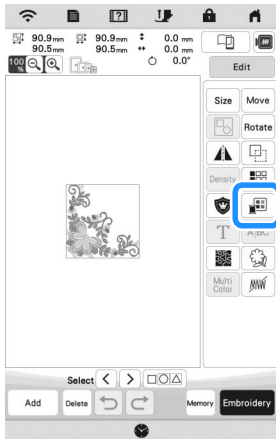

You can change the thread color by moving the color to be changed to the top of the embroidering order and selecting a new color from the thread colors in the machine.

1 Touch  , and then touch .



→ The thread color palette appears.

2 Touch the color of the part to be changed.

\* Touch  or  to display the thread color that is not on the screen.

→ The selected thread color image appears.

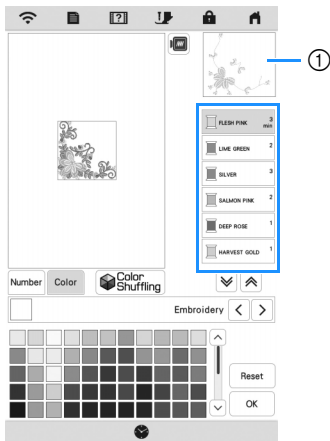

① Selected thread color image

### Memo

- When you directly touch a part of the pattern whose color is to be changed, the part can be selected and displayed.

3 Select a new color from the thread color palette, and then touch .

\* To return to the original color, touch  . If multiple colors have been changed, this command will return all colors to their original colors.

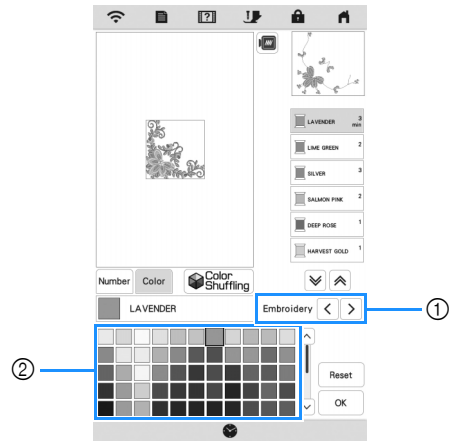

① Thread brand for colors

② Thread color palette

→ The display shows the changed colors.

### Memo

- Touch  to specify a thread color by entering its number. If you enter the wrong number, touch  , and then enter the correct number. After entering the number, touch .



## Finding New Color Schemes with the Color Shuffling Function

With the color shuffling function, the machine suggests new color schemes for the embroidery pattern that you have selected. After you select the desired effect ([Random], [Vivid], [Gradient] or [Soft]), sample color schemes for the selected effect are displayed.

1 Touch **Edit**, and then touch .

2 Touch  **Color Shuffling**.

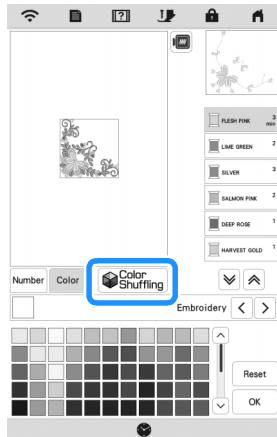

### Memo

- This function may not be available depending on the pattern you select (ex. a repeated pattern, licensed pattern).

3 Select the thread brand for colors and the number of colors you want to create the pattern with.

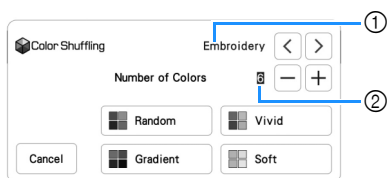

- ① Thread brand for colors
- ② Number of colors to be used

4 Select the desired effect.



- ① Effects for schemes
  - If you select [Random] or [Gradient], the color specifying screen will appear.
  - If you select [Vivid] or [Soft], proceed to step 7.

5 Touch **Auto** **Manual** to set **Manual** and specify the thread color to use in the effect.

- \* If you don't need to specify the thread color, just set to **Auto**.

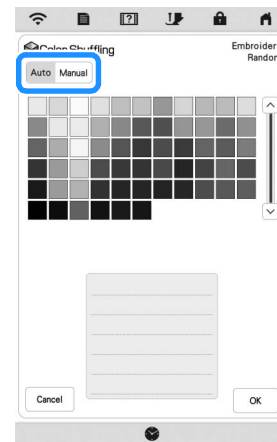

### [Manual] setting for [Random]

You can select up to 6 colors to be used in the [Random] effect. The effect will be created using the selected colors.

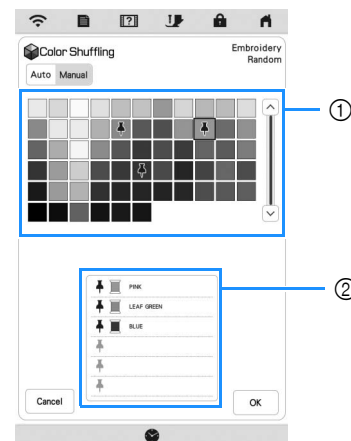

- ① Select colors from the palette.
- ② Selected colors are listed.

**[Manual] setting for [Gradient]**

You can select one color to be used in the [Gradient] effect. The effect will be created with a color you select.

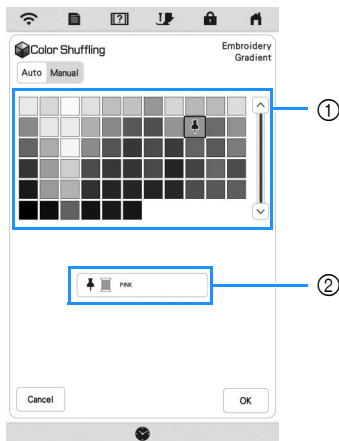

- ① Select a color from the palette.
- ② Selected color is displayed.

**6** Touch .

**7** Select the desired color scheme from samples.

\* Touch  to add the new schemes.

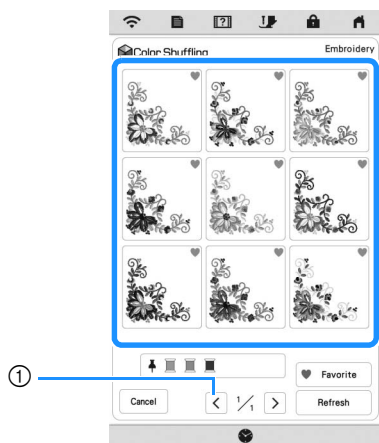

① Touch to review the previous schemes.

**Memo**

- To temporarily register your favorite schemes, touch (to release your favorite schemes, touch again). 9 color schemes can be added. Touch  to check the registered favorite schemes.

To cancel the registration, touch .

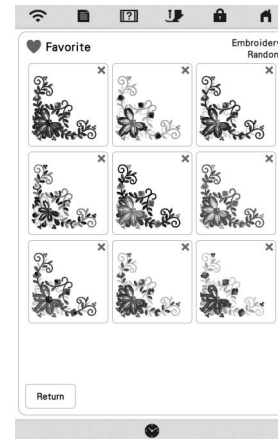

- Maximum 20 pages of schemes can be reviewed.

**8** Select the displayed color scheme.

- \*  : Return to the previous screen.
- \*  or  : Display the other color schemes.
- \*  : Select the displayed color scheme.



→ The thread color palette screen will appear.

**Thread Color Sorting**

This function allows you to embroider while replacing the thread spool a minimal number of times.

Before starting to embroider, touch  in the embroidery screen to rearrange the embroidery order and sort it by thread colors.

1 Touch **Layout** in the embroidery screen.

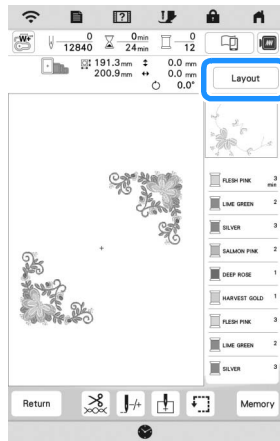

2 Touch .

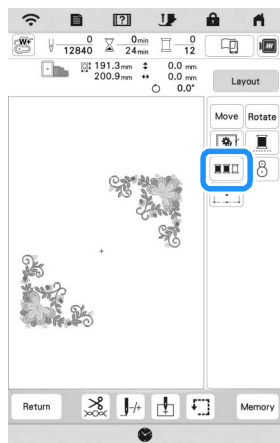

\* Touch **Layout** again to check the sorted thread colors.

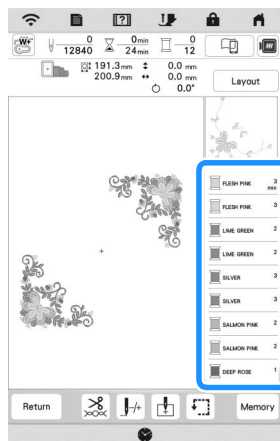

→ The embroidery color order is rearranged and sorted by thread colors.

\* Touch **Layout**, then  to cancel color sorting and embroider with the original embroidery color order.

### Note

- This function does not work on overlapping patterns.

## VIEWING THE EMBROIDERY SCREEN

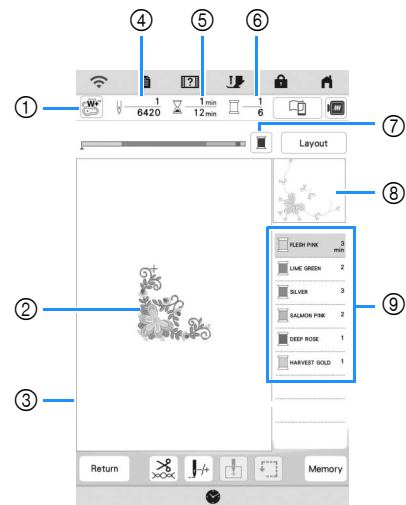

\* This screen appears when embroidery starts.

- The presser foot symbol  
Attach embroidery foot "W+" with LED pointer or embroidery foot "W" (sold separately) for all embroidery projects.
  - A preview of the pattern
  - The boundary for embroidering with the selected frame in the settings screen
  - Total number of stitches in the selected pattern and number of stitches that have already been embroidered
  - The time necessary to embroider the pattern, and the time already spent embroidering the pattern (not including time for changing and automatically trimming the thread)
  - The number of colors in the pattern, and the number of the color currently being embroidered
  - Switch the progress bar (which shows the embroidering progress) between showing only one color or all colors. This key appears after starting embroidering or after touching the  key.
  - The part of the embroidery pattern that will be embroidered with the thread color at the top of the list
  - The order for thread color changes and the embroidering time for each thread color
- \* The displayed time is the approximate time that will be required. The actual embroidering time may be longer than the displayed time, depending on the embroidery frame that is used. In addition, the amount of time required to change thread colors is not included.

### Key Functions





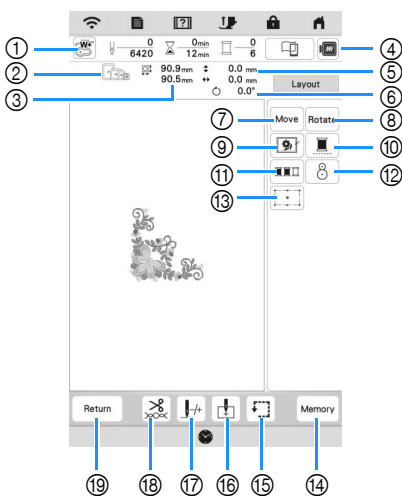

Using these keys, you can move or rotate pattern, etc.















Touch  to display the editing window.



**Note**

- Some operations or functions are not available for certain patterns. If the key display is grayed out, you cannot use that function or operation with the selected pattern.

No.	Display	Explanation	Page
	Name		
①		Turn on the light of the LED pointer.	57
	Needle point check key	Touch this key to check the needle drop point with the light of the LED pointer.	
②		Shows the embroidery frames that can be used for the selected pattern. Be sure to use the proper frame.	54
	Available frames		
③	90.9 mm ⇕ 90.5 mm ⇔	Shows the size of the selected pattern.	—
	Pattern size		
④		Preview the embroidery image.	41
	Image key		
⑤	0.0 mm 0.0 mm	Shows the distance between the embroidering position and the center (when the embroidery pattern is moved).	—
	Distance		
⑥	 0.0°	Shows the degree of rotation of the pattern.	—
	Degree		
⑦		Display the pattern moving window.	—
	Move key		
⑧		Display the pattern rotating window.	—
	Rotate key		
⑨		Add the basting stitch around the pattern. You can select the distance from the pattern to the basting stitching.	14, 71
	Basting key		

No.	Display	Explanation	Page
	Name		
⑩		Change the setting to embroider the pattern with a single color.	—
	Uninterrupted embroidery key	Touch the key again to return to the original setting. Even if uninterrupted embroidering  has been set, the automatic thread cutting function and the thread trimming function can be used. The icons of the spool of thread are grayed out.	
⑪		Touch this key to rearrange the stitching sequence for combined patterns.	50
	Thread sorting key		
⑫		Touch this key to align the embroidering position.	59
	Embroidery positioning key		
⑬		Switch on/off the 2-point embroidery positioning function with a LED pointer.	61
	2-point embroidery positioning function with a LED pointer on/off key		
⑭		Save the pattern to the machine's memory or USB media. The pattern can also be transferred to a computer via a wireless network connection.	81
	Memory key		
⑮		Check the position of the pattern.	60
	Trace key	<ul style="list-style-type: none"> <li>: Move the carriage to trace the embroidery area of the pattern. This allows you to check that there is enough space to embroider the pattern.</li> <li>: Move the carriage to the selected position.</li> </ul>	
⑯		Specify the needle start position.	79, 80
	Starting point key	<ul style="list-style-type: none"> <li>: Set the needle start position to the lower-left corner of the pattern. This setting is useful when connecting patterns since it allows you to continue embroidering until the first stitch of the next pattern.</li> <li>: Move the carriage to the selected position.</li> </ul>	
⑰		Move the needle forward or back in the pattern; useful if the thread breaks while embroidering or if you want to start again from the beginning.	68
	Forward/Back key		
⑱		Set automatic thread cutting, thread trimming or the thread tension. For embroidery, these functions are set automatically.	75-78
	Cut/Tension key		

No.	Display	Explanation	Page
	Name		
⑩	Return	Return to the edit screen.	—
	Return key		



## PREPARING THE FABRIC

### ⚠ CAUTION

- Use fabrics with a thickness of less than 2 mm (approx. 1/16 inch). Using fabrics thicker than 2 mm (approx. 1/16 inch) may cause the needle to break and cause injury.

#### 📝 Memo

- When using layers with thicker batting etc., you can embroider more attractive finishes by adjusting the embroidery presser foot height in the embroidery settings screen.

Touch , and use  and  in the [Embroidery Foot Height] in the embroidery settings screen. Adjust the presser foot height for thick or puffy fabrics.



- To increase the space between the embroidery foot and the needle plate, set the [Embroidery Foot Height] to a larger number.
- In the case of thick terry cloth towels, we recommend that you place a piece of water soluble stabilizer on the top surface of the towel. This will help to reduce the nap of the toweling and result in more attractive embroidery.

### Attaching Iron-on Stabilizers (Backing) to the Fabric

### ⚠ CAUTION

- Always use a stabilizer material for embroidery when embroidering on stretch fabrics, lightweight fabrics, fabrics with a coarse weave, or fabrics which cause pattern shrinkage. Otherwise, the needle may break and cause injury.

#### 1 Iron the iron-on stabilizer material to the wrong side of the fabric.

- Use a piece of stabilizer which is larger than the embroidery frame being used.

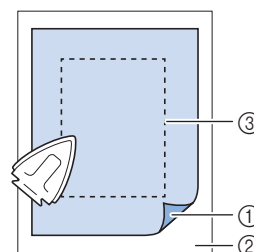

- ① Fusible side of stabilizer
- ② Fabric (wrong side)
- ③ Size of the embroidery frame



**Memo**

- When embroidering small pieces of fabric that cannot be hooped in an embroidery frame, use stabilizer material as a base. After lightly ironing the fabric to the stabilizer material, hoop it in the embroidery frame. If stabilizer material cannot be ironed onto the fabric, attach it with a basting stitch. After completing the embroidery, remove the stabilizer material carefully.

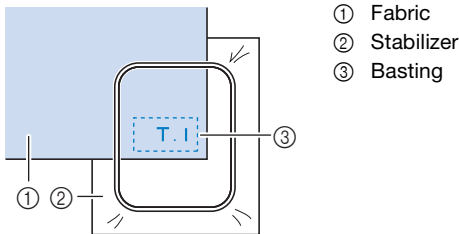

- When embroidering on thin fabrics such as organdy or lawn, or on napped fabrics such as towel or corduroy, use water soluble stabilizer (sold separately) for best results. The water soluble stabilizer material will dissolve completely in water, giving the project a more attractive finish.

## Hooping the Fabric in the Embroidery Frame

### Types of Embroidery Frames

Optional embroidery frames can be used. When choosing frames that do not appear on the screen, be sure to check the design size of the embroidery field of the optional frame. Check with your authorized Brother dealer for frame compatibility.

Select a frame that matches the pattern size. Available frame options are displayed on the LCD.

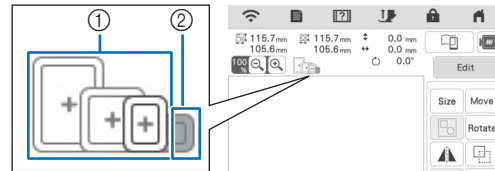

- ① Highlighted: Can be used
- ② Shaded: Cannot be used

### Inserting the Fabric

**Note**

- If the fabric is not securely held in the embroidery frame, the pattern will embroider out poorly. Insert the fabric on a level surface, and gently stretch the fabric taut in the frame.
- Embroidery frames with factory-coded stickers can be used with the application (My Design Snap). (page 107)

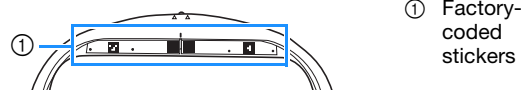

- Lift-up and loosen the frame adjustment screw and remove the inner frame.

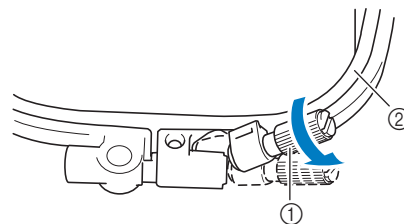

- ① Frame adjustment screw
- ② Inner frame

- Lay the fabric right side up on top of the outer frame.

- 3** Insert the inner frame making sure to align the inner frame's  $\triangle$  with the outer frame's  $\nabla$ .

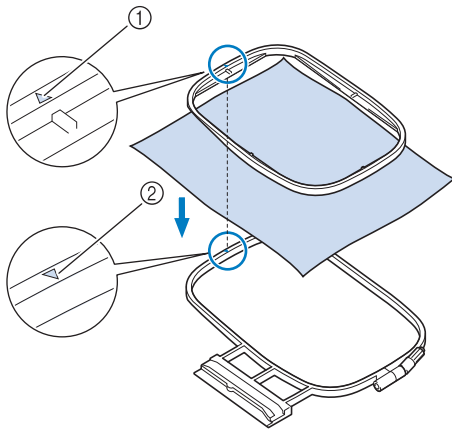

- ① Inner frame's  $\triangle$
- ② Outer frame's  $\nabla$

- 4** Slightly tighten the frame adjustment screw.

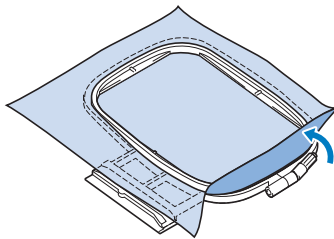

- 5** Gently smooth out the fabric. Make sure fabric is flat and without wrinkles.

\* After stretching the fabric, make sure the fabric is taut.

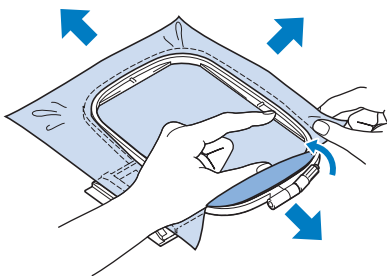

\* Make sure the inside and outside frames are even before you start embroidering.

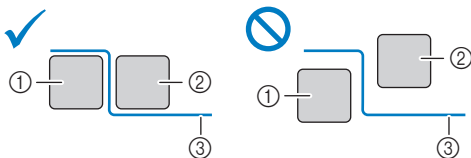

- ① Outer frame
- ② Inner frame
- ③ Fabric

- 6** Tighten the frame adjustment screw to keep the fabric from loosening while stitching.

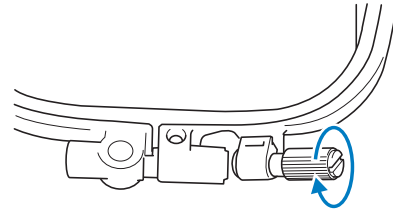

- 7** Return the frame adjustment screw to its initial position.

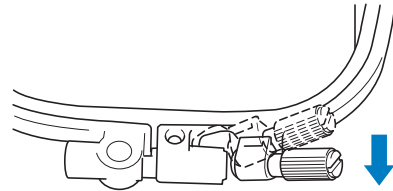

**Memo**

- You can use the disc-shaped screw driver, when you loosen or tighten the frame adjustment screw.

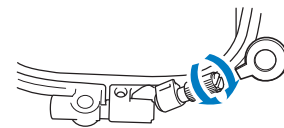

**Using the Embroidery Sheet**

When you want to embroider the pattern in a particular place, use the embroidery sheet with the frame.

- 1** With a chalk pencil, mark the area of the fabric you want to embroider.

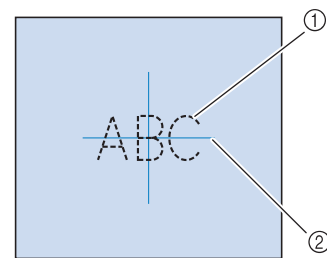

- ① Embroidery pattern
- ② Mark

- 2** Place the embroidery sheet on the inner frame. Align the guide lines on the embroidery sheet with the mark you made on the fabric.

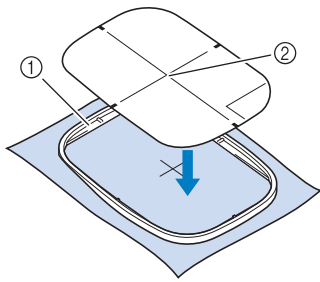

- ① Inner frame  
② Guide line

- 3** Gently stretch the fabric so there are no folds or wrinkles, and press the inner frame into the outer frame.

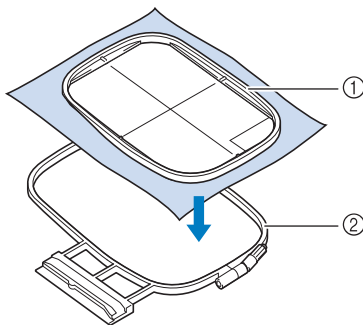

- ① Inner frame  
② Outer frame

- 4** Remove the embroidery sheet.

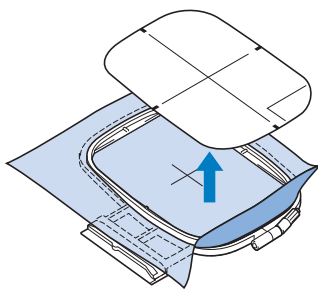

## ATTACHING THE EMBROIDERY FRAME

### Note



- Wind embroidery bobbin thread and insert the bobbin before attaching the embroidery frame. Check that there is enough thread in the bobbin.
- Make sure that the frame-securing lever is correctly lowered after the embroidery frame has been installed in the embroidery frame holder.

- 1** Press  (Presser foot lifter button) to raise the presser foot.

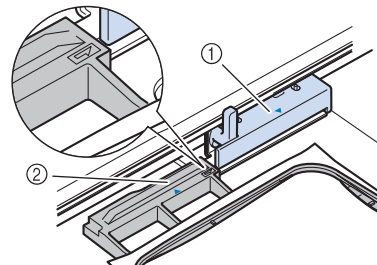
- 2** Align the embroidery frame guide with the right edge of the embroidery frame holder.



- ① Embroidery frame holder  
② Embroidery frame guide

- 3** Slide the embroidery frame into the holder, making sure to align the embroidery frame's  with the holder's .

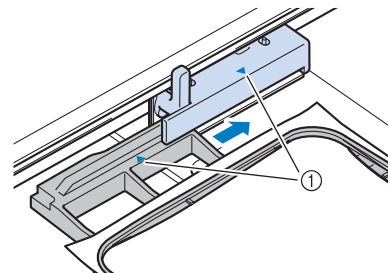

- ① Arrow mark

- 4** Lower the frame-securing lever to be level with the frame to secure the embroidery frame in the embroidery frame holder.

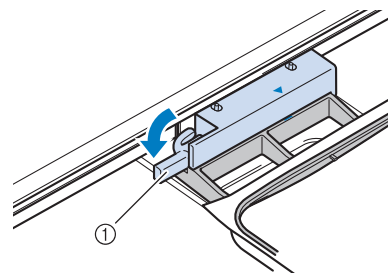

- ① Frame-securing lever

## ■ Removing the Embroidery Frame

- 1 Press  (Presser foot lifter button) to raise the presser foot.
- 2 Raise the frame-securing lever.

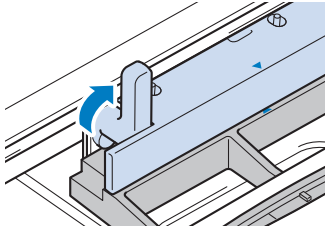

- 3 Pull the embroidery frame toward you.

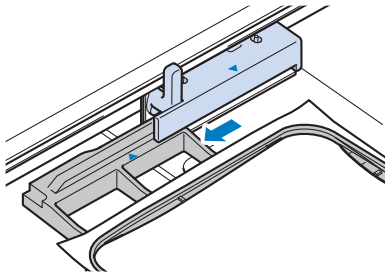

## CONFIRMING THE PATTERN POSITION



The pattern is normally positioned in the center of the embroidery frame. If the pattern needs to be repositioned for better placement on the garment, you can check the layout before starting embroidery.

### Checking the Needle Drop Point with the Embroidery Foot “W+” with LED Pointer

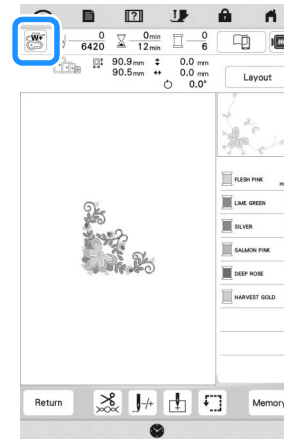
- 1 Touch  in the embroidery screen.  
→ The LED pointer indicates the needle drop point.



#### Memo



- When the LED pointer turns on, the presser foot height is automatically adjusted according to the fabric thickness.
-  appears when the embroidery foot “W+” with LED pointer is attached to the machine.
- If  is not displayed, you cannot use the LED pointer.
- The LED pointer turns off automatically by lowering the presser foot or returning to the previous page.

#### Note

- With spongy fabric, the position may not be accurate due to the various depths of the fabric.
- With fabric that has a very uneven surface such as quilting, the fabric thickness may not be correctly measured. In this case, the pointer indication should be used only as a reference.

## ■ Adjusting the LED Pointer

Adjust the LED pointer if it indicates a point different than the actual needle drop point. Before adjusting the LED pointer, mark the actual needle drop point on the fabric to be embroidered, and attach the embroidery frame.

- 1 Touch .  
→ The settings screen appears.
- 2 Touch .  
→ The embroidery settings screen appears.

**3** Display [Embroidery Foot with LED Pointer Adjustment] in the embroidery setting screen.

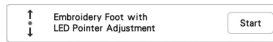

**Note**

- As a default, **Start** appears gray. After the embroidery foot “W+” with LED pointer is attached to the machine, the key becomes available and settings can be specified.

**4** Touch **Start**.

→ The Embroidery Foot “W+” with LED Pointer Adjustment screen appears.

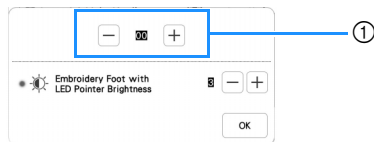

① LED pointer adjustment

**Note**

- The specified setting is saved in the machine’s memory. This is useful for positioning during continuous embroidering.
- For normal use, return the setting to [00].

**5** Use **-** or **+** to adjust the LED pointer so that it indicates the actual needle drop point.

**Memo**

- In order to more accurately check the needle drop point, turn the handwheel toward you (counterclockwise) to lower the needle.

**6** Touch **OK** to return to the original screen.

**Adjusting the Brightness of the LED Pointer**

**1** Follow the steps from **1** to **3** of “Adjusting the LED Pointer” on page 57 to display the embroidery foot with LED pointer adjustment screen.

**2** Use **-** or **+** to adjust the brightness of the LED pointer.



**3** Touch **OK** to return to the original screen.

**Displaying a Background Image**

Using a special application downloaded to a smartphone or tablet, you can transfer a photo of the hooped fabric to be embroidered to the machine to be used as a background image.

The embroidery frame is displayed in the application. You can see how the pattern will be arranged on the actual fabric.

For details, refer to “MY DESIGN SNAP APP” on page 107.

**Note**

- The wireless network settings must first be specified on the machine. Refer to “WIRELESS NETWORK CONNECTION FUNCTIONS” on page 18.
- Embroidery frames with factory-coded stickers can be used with the application (My Design Snap).

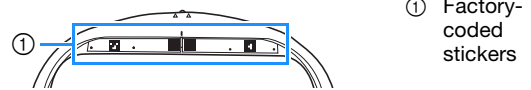

① Factory-coded stickers

**Displaying the Background Image on the Screen of the Machine**

**1** Select the pattern. (page 33)

**2** Photograph the fabric in the frame with the easy mode of the application, and then transfer it to the machine.

For a detailed procedure, refer to the application.

**3** Touch **OK**.

\* Attach the frame used in the image before touching

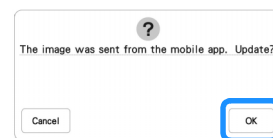

→ The transferred background image appears on the screen of the machine.

**Memo**

- To hide the background image, touch .
- Touch to display the background image again.
- The transferred background image includes the embroidery frame display.

### ■ Calibrating the Position of the Background Image

By calibrating the position of the background image transferred to the machine, the pattern can be positioned more accurately.

- 1 Select a pattern. (page 33)
- 2 Set the application to advanced mode, attach the embroidery positioning sticker to the fabric in the hoop, take the photo of the background, and with the advanced mode of the application, transfer it to the machine.

For a detailed procedure, refer to the application.

- 3 Touch .
  - \* Attach the frame used in the image before touching .

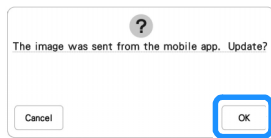

→ The carriage will move, and the LED pointer will turn on.

- 4 Use  to align the LED pointer with the center of the larger circle in the embroidery positioning sticker.

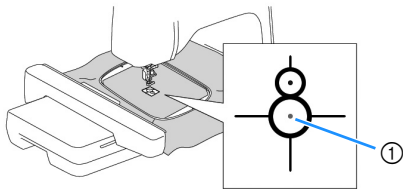

- ① Center of the larger circle in the embroidery positioning sticker

#### Memo

- The position can also be calibrated by lowering the needle with the handwheel. This method enables more accurate positioning. Slowly turn the handwheel toward you (counterclockwise) to check the needle drop point. Then, turn the handwheel away from you (clockwise) until the mark on the handwheel is at the top. The carriage cannot move if the mark on the handwheel is not at the top.

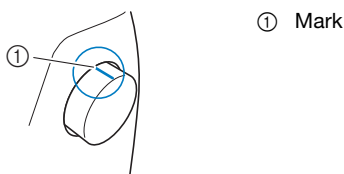

- 5 Touch .
  - The position of the background image is calibrated.

### ■ Aligning the Embroidering Position

- 1 Calibrate the position of the background image. (page 59)
- 2 Touch .

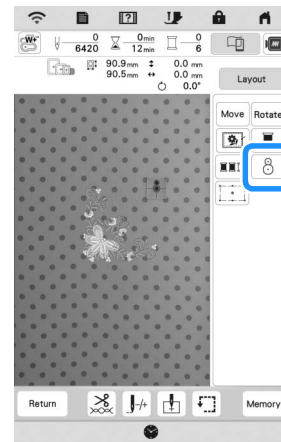

#### Memo

- The orientation of the pattern will change depending on the orientation of the embroidery positioning sticker.

- 3 When the following message appears, touch .

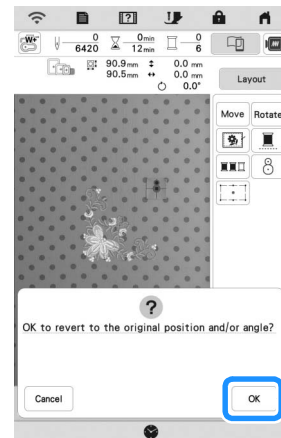

- 4 Select the position to be set as the reference point.

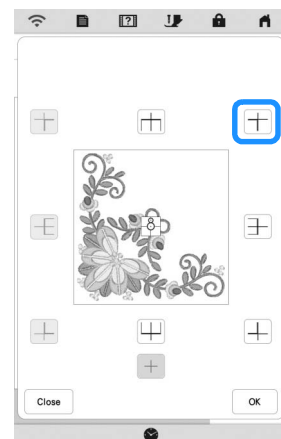

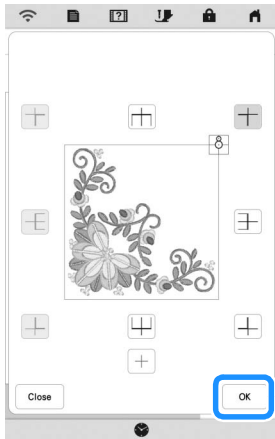

5 Touch .

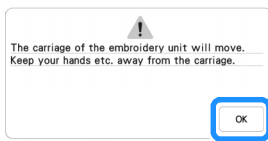

→ When the following message appears, touch .



6 Remove the embroidery positioning sticker, and then start embroidering.

\* To remove the embroidery positioning sticker more easily, touch  so that the embroidery frame moves slightly forward and away from under the needle. After the embroidery positioning sticker is removed, touch .

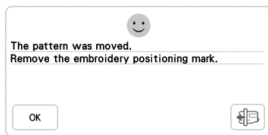

### Checking the Pattern Position

The carriage moves and shows the pattern position. Watch the embroidery frame closely to make sure the pattern will be embroidered in the right place.

1 Touch .

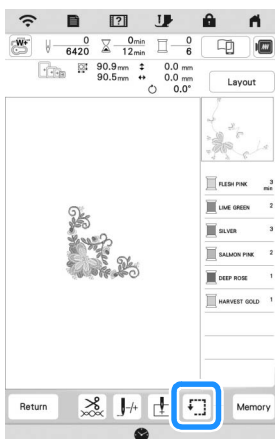

2 From , touch the key for the position that you want to check.

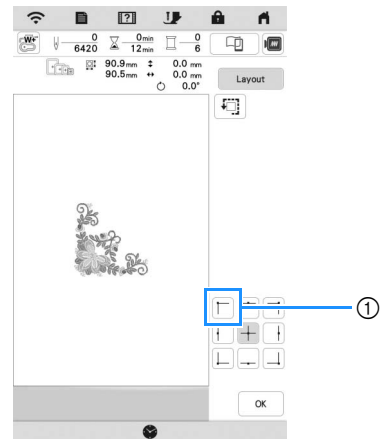

① Selected position

→ The carriage will move to the selected position on the pattern.

### Memo

- To see the entire embroidering area, touch . The carriage moves and shows the embroidery area.

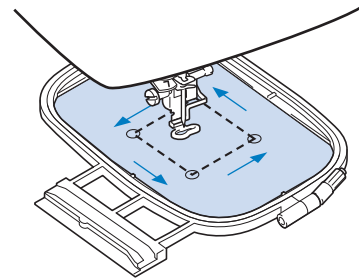

## CAUTION

- Do not lower the needle when the embroidery frame is moving. If the needle is down, it could break and result in injury.

3 Touch .



# THE 2-POINT EMBROIDERY POSITIONING FUNCTION

By using the 2-point embroidery positioning function with a LED pointer, the embroidering position can easily be aligned. This is useful when embroidering in an area where it is necessary to align the pattern, as shown below.

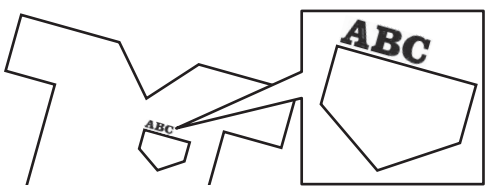

**1 Use a chalk pencil to mark the desired embroidering position.**

The line drawn for the reference direction should be longer.

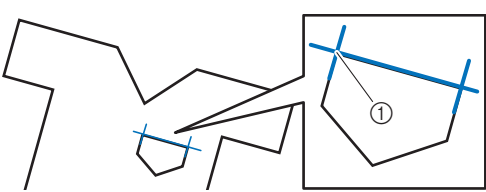

① Chalk pencil mark

**Memo**

- If the desired position of the pattern can be clearly established, such as when embroidering along a pocket, it is not necessary to mark the position with a chalk pencil.

**2 Hoop the fabric in the embroidery frame.**

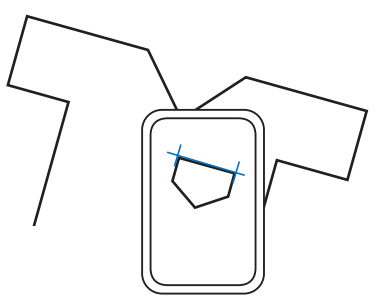

**Note**

- When hooping the fabric in the embroidery frame, make sure that the embroidery pattern will fit within the embroidering area of the frame being used.

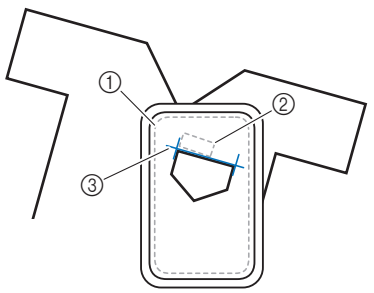

- ① Embroidering area
- ② Embroidery pattern size
- ③ Chalk pencil mark

**3 Select the pattern.**

**4 Touch **Embroidery** to display the embroidery screen.**

**5 Touch **Layout** and then touch .**

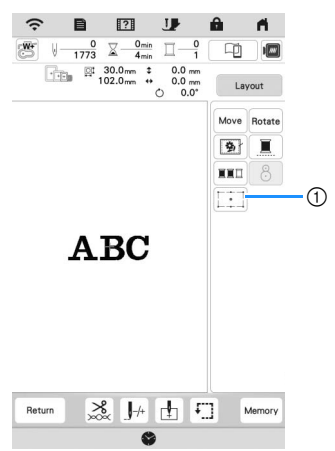

① Switch on/off the 2-point embroidery positioning function with a LED pointer.

**Memo**

- The LED pointer lights up to indicate the needle drop point.
- When the LED pointer is turned on, the embroidery foot height is automatically adjusted according to the fabric thickness.
- If the surface of the fabric is too uneven or rough, check and adjust the alignment of the light of the LED pointer and the needle drop point before starting to embroider.

**6 If a message appears, indicating that the move and rotate settings will return to the original ones, touch **OK**.**

**7 From the reference points shown in the screen, select the point to be used for aligning the pattern.**

For this example, select the point in the lower-left corner of the pattern.

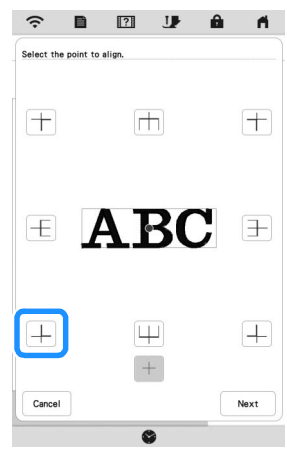



8 Touch Next.

9 Select the direction (from the reference point) to be used as a reference for aligning the pattern.

For this example, select the arrow pointing to the right as the reference direction.

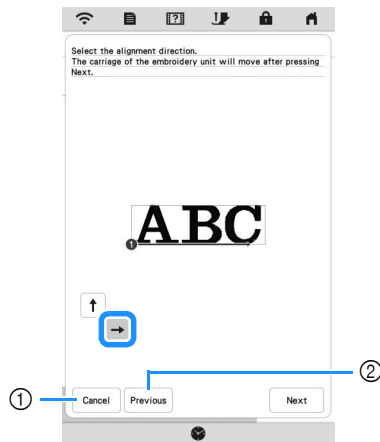

- ① Cancel the pattern alignment settings.
- ② Return to the previous screen.

10 Touch Next.

11 Touch the positioning keys to move the embroidery frame until the position of the LED pointer and the center of the first mark are aligned.

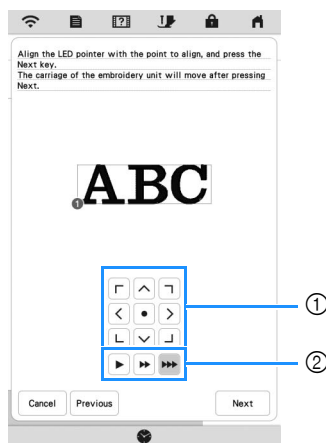

To change the speed that the frame moves, use the frame movement speed keys. If it is difficult to make a precision alignment, touch a frame movement speed key for a slower speed.

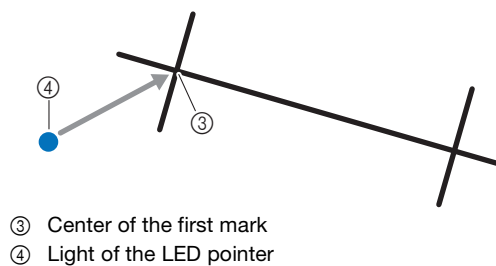

- ① Positioning keys
- ② Frame movement speed keys



Note

- If  is displayed to the left of the positioning keys, the LED pointer has shifted from its initial position. Touch  to adjust the position.

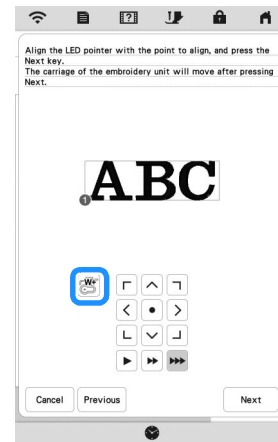

12 Touch Next.

13 Touch the positioning keys to move the embroidery frame until the position of the LED pointer and the center of the second mark are aligned.

To change the speed that the frame moves, use the frame movement speed keys. If it is difficult to make a precision alignment, touch a frame movement speed key for a slower speed.

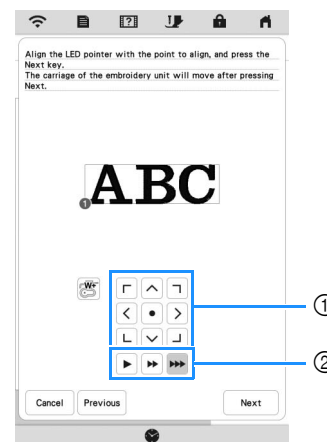

- ① Positioning keys
- ② Frame movement speed keys

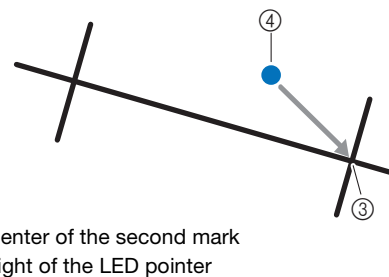

**Note**

- Set the position of the LED pointer to a position that is not too close to the first reference point. If it is too close, a message will appear, prompting you to reposition it.
- In order to increase the accuracy of the pattern alignment, align the position of the LED pointer above the second mark (③) and as far away from the center mark as possible.

**14** Touch **Set**.

→ The pattern is repositioned.

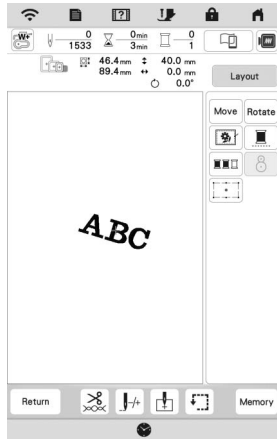

**15** Press the “Start/Stop” button to start embroidering.

**Another example**

By specifying an alignment point and direction, embroidery patterns can be positioned and aligned for various purposes.

In this example, a pattern is aligned at the left center of the towel.

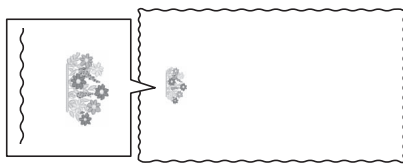

**1** Use a chalk pencil to mark the desired embroidering position.

The line drawn for the reference direction should be longer.

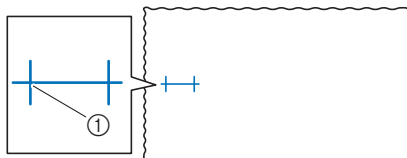

① Chalk pencil mark

**2** Hoop the fabric in the embroidery frame.

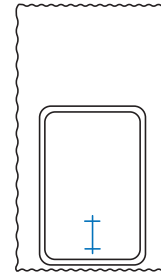

**3** Select the pattern.

**4** Touch **Embroidery** to display the embroidery screen.

**5** Touch **Layout** and then touch .

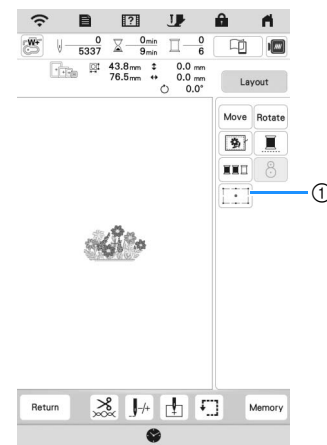

① Switch on/off the 2-point embroidery positioning function with a LED pointer.

**6** If a message appears, indicating that the move and rotate settings will return to the original ones, touch **OK**.

**7** From the reference points shown in the screen, select the point to be used for aligning the pattern.

For this example, select the point in the lower-center of the pattern.

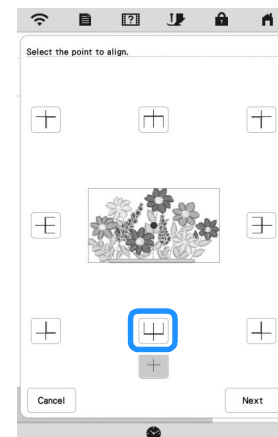

8 Touch **Next**.

9 Select the direction (from the reference point) to be used as a reference for aligning the pattern.

For this example, select the arrow pointing upward as the reference direction.

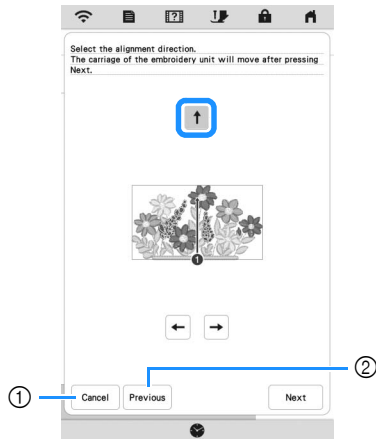

- ① Cancel the pattern alignment settings.
- ② Return to the previous screen.

10 Touch **Next**.

11 Touch the positioning keys to move the embroidery frame until the position of the LED pointer and the center of the first mark are aligned.

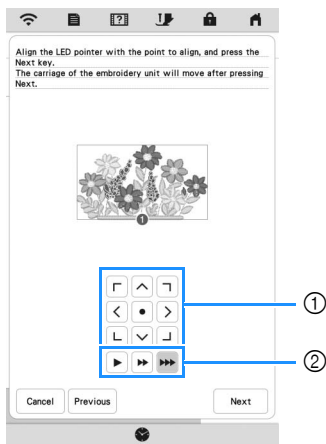

- ① Positioning keys
- ② Frame movement speed keys

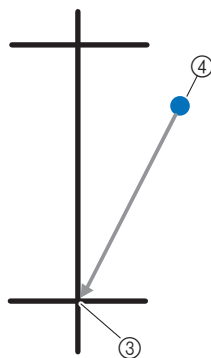

- ③ Center of the first mark
- ④ Light of the LED pointer

12 Touch **Next**.

13 Touch the positioning keys to move the embroidery frame until the position of the LED pointer and the center of the second mark are aligned.

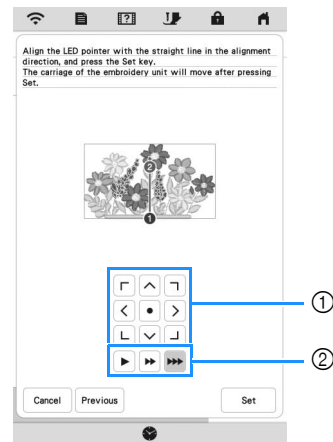

- ① Positioning keys
- ② Frame movement speed keys

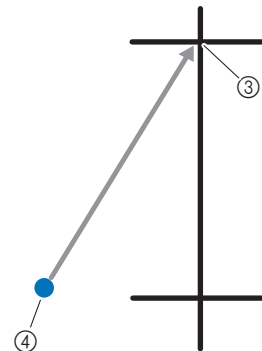

- ③ Center of the second mark
- ④ Light of the LED pointer

14 Touch **Set**.

→ The pattern is repositioned.

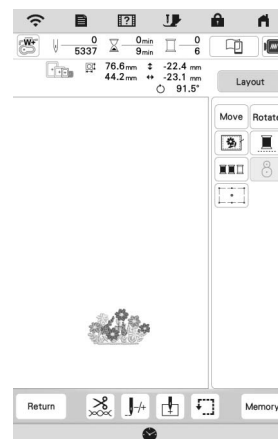

15 Press the "Start/Stop" button to start embroidering.

## EMBROIDERING A PATTERN

### Embroidering Attractive Finishes

Many factors are involved in achieving a beautiful embroidery result. Using the appropriate stabilizer (page 53) and hooping the fabric in the frame (page 54) are two important factors mentioned earlier. Another important point is the appropriateness of the needle and thread being used. See the explanation of threads below.

Thread	Upper thread	Use embroidery thread intended for use with this machine.
	Bobbin thread	Use embroidery bobbin thread intended for use with this machine.

#### Memo

- If you use threads other than those listed above, the embroidery may not embroider out correctly.

**Bobbin case (recommended for embroidering with included 90 weight bobbin thread)**

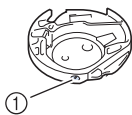

① Bobbin case

The included bobbin case is set for 90 weight bobbin thread. When you use different weights of bobbin thread, the tension screw on this bobbin case can be adjusted if necessary. For details, refer to “Adjusting the Bobbin Case” on page 76.

### CAUTION

- When embroidering on large items (especially jackets or quilts), do not let the fabric hang off of the table. Otherwise, the embroidery unit cannot move freely and the embroidery frame may strike the needle, causing the needle to break and possibly causing injury.

### Embroidery Needle Plate Cover

Under some conditions, based on the type of fabric, stabilizer, or thread being used, there may be some looping in the upper thread. In this case, attach the included embroidery needle plate cover to the needle plate. Attach the cover by inserting the two projections on the underside of the cover into the notches on the needle plate as shown below.

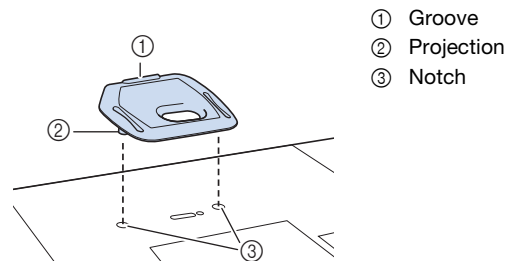

- ① Groove
- ② Projection
- ③ Notch

To remove the embroidery needle plate cover, place your fingernail in the groove and lift the plate out.

### CAUTION

- Push the embroidery needle plate cover as far as possible to attach it. If the embroidery needle plate cover is not securely attached, it may cause the needle to break and cause injury.

### Embroidering Patterns

- Prepare embroidery threads of the colors shown on the screen.

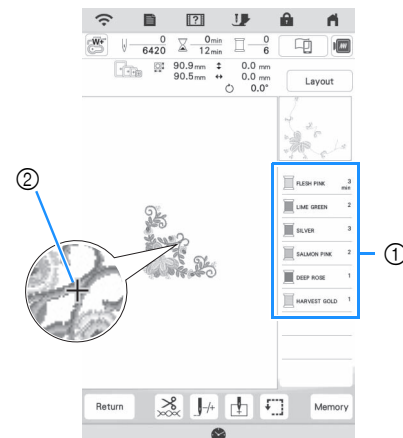

- ① Embroidery color order
- ② Cursor

#### Memo

- The [+ ] cursor moves over the pattern, showing which part of the pattern is being embroidered.

- 2** Using the automatic needle threader, thread the machine for the first color. (page 26)

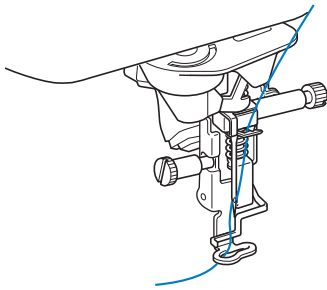

- 3** Lower the presser foot, then press the “Start/Stop” button to start embroidering.

→ When the first color is completely embroidered, the machine will automatically trim the threads and stop. The embroidery foot will then automatically be raised. On the embroidery color order display, the next color will move to the top.

**Memo**

- If you want to get more attractive finishes, try the procedures below;
  - After 5-6 stitches, press the “Start/Stop” button again to stop the machine.
  - Trim the excess thread at the beginning of the pattern. If the excess thread tail is under the embroidery foot, raise the embroidery foot, then trim the excess thread.

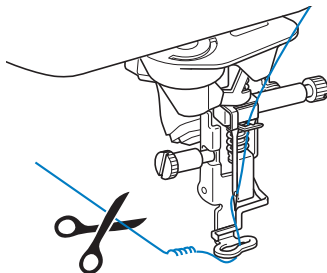

- If there is thread left over from the beginning of embroidering, it may be embroidered over as you continue embroidering the pattern, making it very difficult to deal with the thread after the pattern is finished. Trim the threads at the beginning of each thread change.

- 4** Remove the upper thread for the first color from the machine. Thread the machine with the next color.

- 5** Repeat the same steps for embroidering the remaining colors.

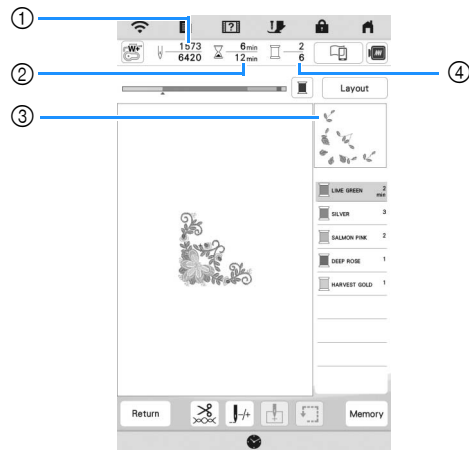



- ① Current stitch numbers/Total stitch numbers
- ② Current time/Total time
- ③ Part of pattern to be embroidered next
- ④ Embroidered colors/Total colors

→ When the last color is embroidered, [Finished embroidering] will appear on the display. Touch , and the display will return to the original screen.

**Memo**



- The thread trimming function is originally set to trim excess thread jumps (threads linking parts of the pattern, etc.). Depending on the type of thread and fabric that are used, an end of upper thread may remain on the surface of the fabric at the beginning of the stitching. After embroidering is finished, cut off this excess thread. If the setting has been turned off, trim the excess thread jumps using scissors after the pattern is finished. Refer to page 78 for information on the thread trimming function.

## IMPORTANT

- Do not press  (Thread cutter button) after the threads have been cut. Doing so could tangle the thread or damage the machine.
- Do not press  (Thread cutter button) when there is no fabric set in the machine or during machine operation. The thread may tangle, possibly resulting in damage.

## Using Appliqués

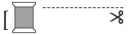
When the color embroidering order display shows

- [ (APPLIQUE MATERIAL)],  
 [ (APPLIQUE POSITION)] or  
 [ (APPLIQUE)], follow the procedure below.

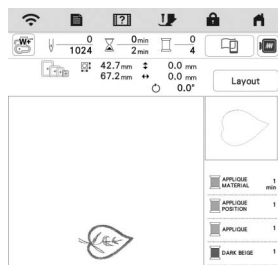

Required materials

- Fabric for the appliqué piece
- Fabric for the appliqué base
- Stabilizer material
- Fabric glue or temporary spray adhesive
- Embroidery thread

### Note

- Refer to “Embroidery Design Guide” to review the recommended method for built-in appliqué patterns. Please visit <https://s.brother/cmekb/>. Some appliqué patterns differ from the procedure described in this manual.
- The correct names and numbers of the thread colors to be used will not appear. Use the thread colors depending on those in the appliqué pattern.

## 1. Creating an Appliqué Piece

- 1 Attach stabilizer material to the wrong side of the fabric for the appliqué piece.
- 2 Sew the cutting line of the appliqué piece. Remove the fabric for the appliqué piece from the embroidery frame, and then carefully cut along the sewn cutting line.

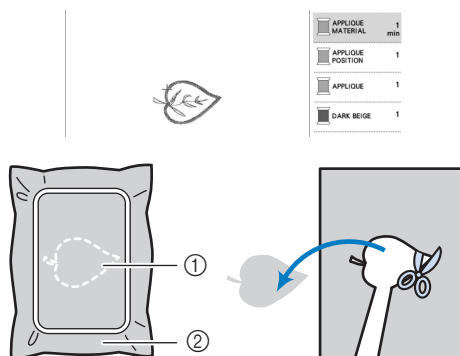

- ① Outline of appliqué  
 ② Fabric for appliqué piece

### Note

- If the appliqué piece is cut out along the inside of the cutting line, it may not be correctly attached to the fabric. Therefore, carefully cut out the appliqué piece along the cutting line.
- After cutting out the appliqué piece, carefully remove the thread.

## 2. Sewing the Appliqué Position on the Base Fabric

- 1 Attach stabilizer material to the wrong side of the fabric for the appliqué base.
- 2 Sew the appliqué position.

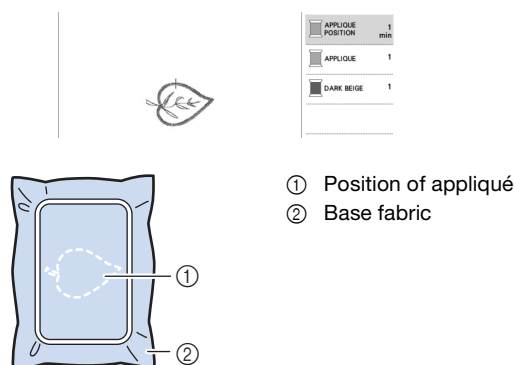

- ① Position of appliqué  
 ② Base fabric

- 3 Remove the embroidery frame from the embroidery unit.

### Note

- Do not remove the base fabric from the embroidery frame until all embroidering is finished.

## 3. Affixing the Appliqué Piece to the Base Fabric

- 1 Lightly apply fabric glue or temporary spray adhesive to the back of the appliqué piece, and then attach it to the base fabric within the outline of the position sewn in step ② of “2. Sewing the Appliqué Position on the Base Fabric”.

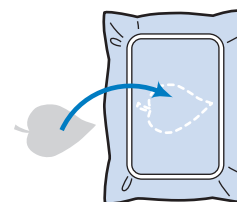

### Note

- If the appliqué piece cannot be attached to the base fabric with fabric glue or temporary spray adhesive, securely baste it in place with basting stitches.
- If thin fabric is used for the appliqué piece, reinforce and secure it in place with an iron-on adhesive sheet. An iron can be used to attach the appliqué piece to the appliqué location.

- 2 After the appliqué piece is attached, attach the embroidery frame to the machine. Thread the machine with the embroidery thread, lower the presser foot lever, and then press the “Start/Stop” button to embroider the appliqué.

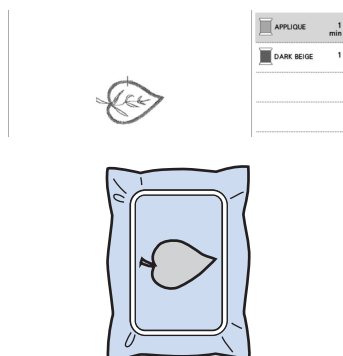

#### 4. Embroidering the Remainder of the Pattern

- 1 Change the embroidery thread according to the embroidery color order display, and then finish embroidering the remainder of the pattern.

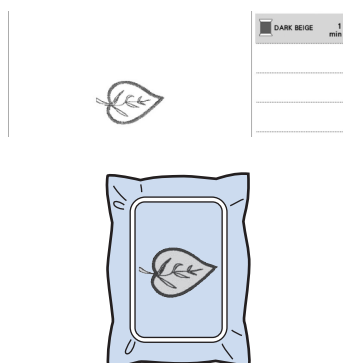

#### Memo

- Since glue may become attached to the presser foot, needle or needle plate, clean off any glue after finishing embroidering the appliqué pattern.
- For best results, trim all excess threads each time the thread color is changed.

## ADJUSTMENTS DURING THE EMBROIDERY PROCESS

### If the Thread Breaks or the Bobbin Runs out of Thread During Embroidering

- 1 Redo the upper threading or replace the bobbin.

If the upper thread breaks, stop the machine, trim the bobbin thread, and then rethread the machine.

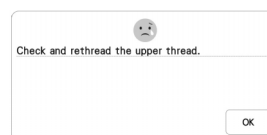

If the bobbin thread is almost empty or broken, touch



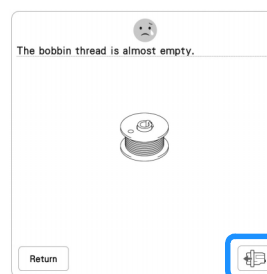

 of the displayed message, remove the embroidery frame, and then replace the bobbin.



#### Note

- If [Upper and Bobbin Thread Sensor] in the settings screen of the machine is set to [OFF], the message shown above does not appear.







- 2 Touch .

- 3 Touch , , , or  to move the needle back the correct number of stitches before the area where the thread broke, and then touch .

- Touch  to restart from the beginning.



#### Memo

- If you cannot move back to the spot where the thread broke, touch  or  to select the color and move to the beginning position of that color, then use , , , or  to move ahead to slightly before where the thread broke.

- 4 Lower the presser foot and press the "Start/Stop" button to continue embroidering.

---

## Resuming Embroidery after Turning off the Power

---

The current color and stitch number are saved when embroidery is stopped. The next time the machine is turned on, you have the option to continue or delete the pattern.

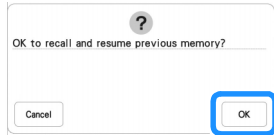





# Chapter 3 ADVANCED EMBROIDERY

## VARIOUS EMBROIDERING FUNCTIONS



### Basting Embroidery

Before embroidering, basting stitches can be sewn along the outline of the pattern. This is useful for embroidering fabric that cannot have stabilizer material affixed with an iron or adhesive. Basting stitches can be used to attach material that cannot be hooped to stabilizer, making it possible to be embroidered.

#### Note

- It is recommended to finish combining and editing the pattern before selecting the basting setting. If the pattern is edited after selecting the basting setting, the basting and pattern may become misaligned, and the basting under the pattern may be difficult to remove after embroidering is complete.

1 Touch .



2 Use  and  to specify the distance from the pattern to the basting stitching.



#### Memo

- The higher the setting, the farther the basting is from the pattern.
- The setting remains selected even if the machine is turned off.

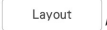
3 Touch  to return to the embroidering screen.

4 Touch , and then touch  to select the basting setting.

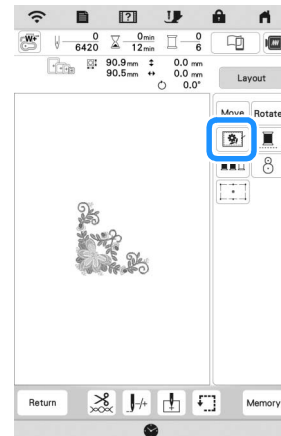

#### Note

- When  is touched, the pattern is moved to the center. After selecting the basting setting, move the pattern to the desired position.

→ Basting is added to the beginning of the embroidering order.

5 Press the "Start/Stop" button to start embroidering.

6 When embroidering is finished, remove the basting stitching.

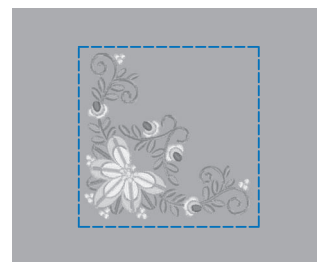

## Creating an Appliqué Piece

Creating an appliqué piece is convenient for fabrics that cannot be embroidered or when you wish to attach an appliqué to a garment.

### ■ Creating an Appliqué Piece

The following pattern will be used to create an appliqué piece.



#### 💡 Note

- Felt or denim fabrics are recommended to make the appliqué piece. Depending on the pattern and fabric used, lighter weight fabrics may cause the stitching to appear smaller.
- For best results, be sure to use stabilizer material for embroidering.
- When making appliqué pieces, do not use the optional border embroidery frame. Depending on the pattern density and fabric used, shrinkage of the stitching may occur.

### 1 Select the pattern, and edit it if necessary.

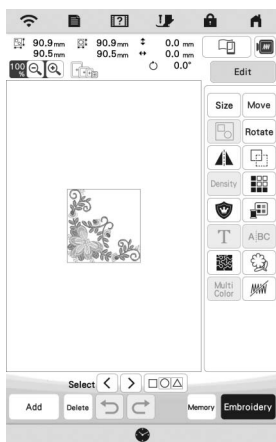

#### 💡 Note

- Finish combining and editing the pattern before selecting the appliqué setting. If the pattern is edited after selecting the appliqué setting, the appliqué stitching and pattern may become misaligned.
- Since an outline is added, the pattern for an appliqué piece (when the appliqué setting is selected) will be larger than the original pattern. First, adjust the size and position of the pattern as shown below.

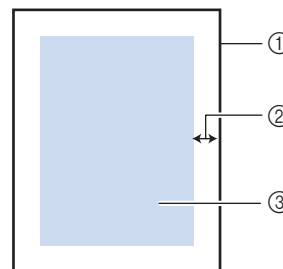

- ① Embroidering area
- ② About 1 cm (approx. 1/2 inch)
- ③ Pattern size

### 2 Touch **Edit** and then, touch .

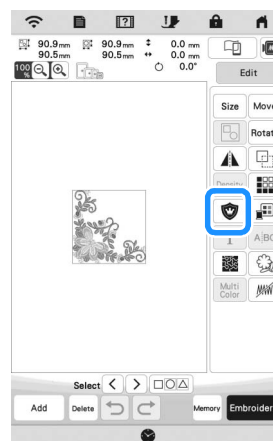

### 3 Specify the distance between the pattern and the appliqué outline, and then touch **OK**.



→ The pattern and appliqué outline are grouped.

**4 Touch Embroidery**

→ The steps for creating the appliqué piece are added to the embroidering order.

**Memo**

- Three steps are added to the embroidering order: appliqué cutting line, position of pattern placement on the stabilizer material, and appliqué stitching.

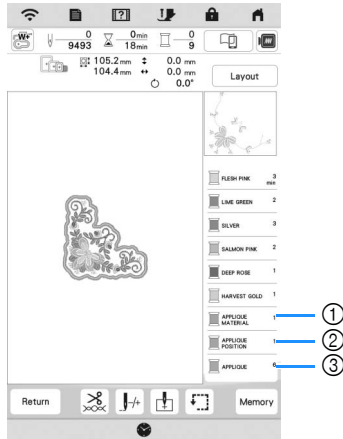

- ① Cutting line for appliqué
- ② Position of pattern placement on stabilizer material
- ③ Appliqué stitching

- When setting the [Thread color] to [#123] (thread number) in the settings screen, the following screen is displayed.

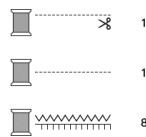

**Note**

- An appliqué piece cannot be created if the pattern is too large or too complicated or a combined pattern is separated. Even if the selected pattern fits within the embroidering area, the entire appliqué pattern may exceed the embroidering area when the outline is added. If an error message appears, select a different pattern or edit it.

**5 Fuse or stick a piece of stabilizer to the back of the felt or denim fabric to be used as the appliqué piece.**

**6 Hoop the fabric for the appliqué piece in the embroidery frame, attach the embroidery frame to the machine, and then start embroidering.**

**7 After the pattern is embroidered, thread the machine with the thread for the cutting line, and then sew the cutting line (APPLIQUE MATERIAL).**

① Cutting line for appliqué

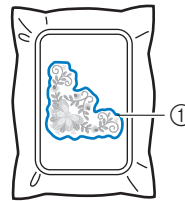

**Memo**

- We recommend using thread for the cutting line that is closest to the color of the fabric.

**8 Remove the fabric for the appliqué piece from the embroidery frame, and then carefully cut along the stitching. After cutting, carefully remove all of the cutting line thread.**

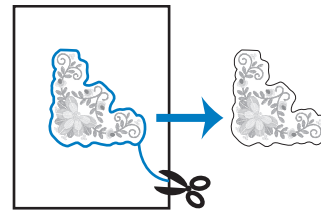

**Note**

- Depending on the pattern density and fabric used, there may be shrinking of the pattern, or the appliqué may be misaligned with the placement line. We recommend cutting slightly outside of the cutting line.
- When using patterns that are vertically and horizontally symmetrical, use a chalk pencil to indicate the pattern orientation before cutting it out.
- Carefully cut out the pattern on the outline you just sewed. Do not cut inside the cutting line, otherwise the appliqué fabric will not be caught by the appliqué stitch.

- 9** Use two layers of adhesive water soluble stabilizer material with their sticky sides together, and then hoop them in the embroidery frame.

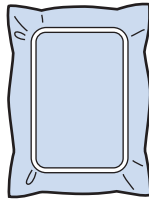

**Note**

- If water soluble stabilizer is used, it is not necessary to remove the stabilizer material after sewing the appliqué outline. To reduce shrinkage of the pattern, we recommend using water soluble stabilizer.
- Put together two layers of water soluble stabilizer, otherwise the stabilizer material may tear during embroidering.

- 10** Thread the machine with the thread for the outline, and then sew the placement line for the appliqué position (APPLIQUE POSITION).

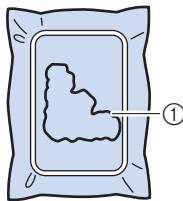

① Pattern placement line

- 11** Lightly apply glue or spray adhesive, and paste the appliqué piece so that it aligns with the placement line.

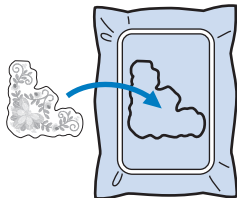

**Note**

- Before pasting the appliqué piece down, make sure the appliqué piece is positioned correctly within the placement line.

- 12** With the machine threaded using the thread for the outline from step 10, embroider the outline (APPLIQUE).

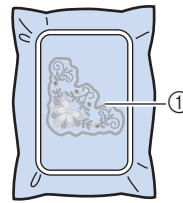

① Outline of appliqué piece

**Memo**

- The outline is sewn using satin stitching.
- Since glue may become attached to the presser foot, needle or needle plate, clean off any glue after finishing embroidering the appliqué pattern.

- 13** After embroidering is finished, remove the stabilizer material from the embroidery frame.

- 14** Use scissors to cut the excess water soluble stabilizer from outside the appliqué outline.

- 15** Soak the appliqué piece in water to dissolve the water soluble stabilizer.

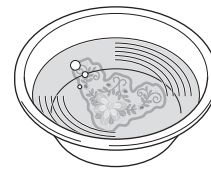

- 16** Dry the appliqué piece, and then iron it if necessary.

**Note**

- Do not apply a strong force when ironing, otherwise the stitching may be damaged.

# MAKING EMBROIDERY ADJUSTMENTS

## Adjusting Thread Tension

When embroidering, the thread tension should be set so that the upper thread can slightly be seen on the wrong side of the fabric.

The following screen appears when you touch .

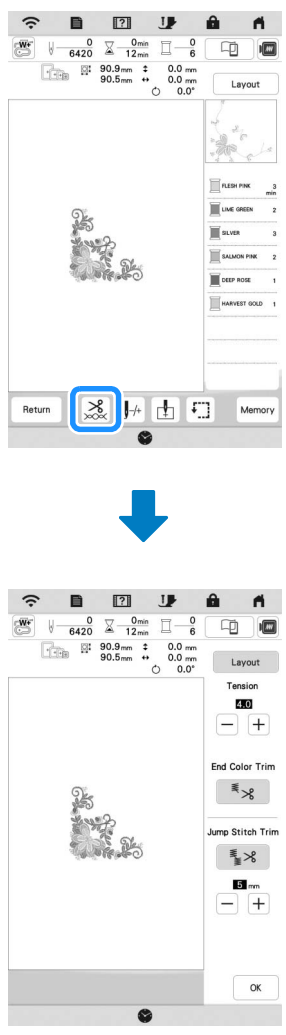

**Memo**

- If the thread tension is changed from the default setting, the new setting will remain after turning the machine off and on. This new setting will apply to any selected design.

**Correct Thread Tension**

The pattern can be seen from the wrong side of the fabric. If the thread tension is not set correctly, the pattern will not finish well. The fabric may pucker or the thread may break.

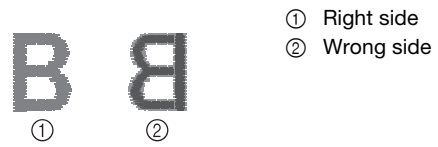

Follow the operations described below to adjust thread tension according to the situation.

**Note**

- If the thread tension setting is made extremely loose, the machine may stop during embroidering. This is not the sign of a malfunction. Increase the thread tension slightly, and start embroidering again.

**Memo**

- If the thread tension is changed from the default setting, the new setting will remain after turning the machine off and on. This new setting will apply to any selected design.

**Upper Thread Is Too Tight**

The tension of the upper thread is too tight, resulting in the bobbin thread being visible from the right side of the fabric.

**Note**

- If the bobbin thread was incorrectly threaded, the upper thread may be too tight. In this case, refer to "Setting the Bobbin" on page 25 and rethread the bobbin thread.



Touch  in **Tension** to weaken the upper thread tension. (The tension number will decrease.)

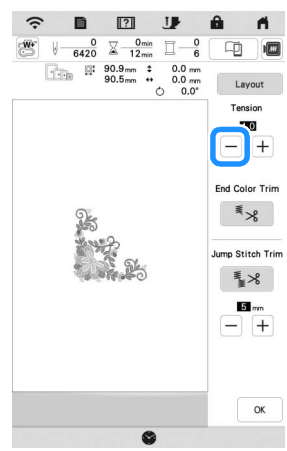

### Upper Thread Is Too Loose

The tension of the upper thread is too loose, resulting in a loose upper thread, loose thread locks, or loops appearing on the right side of the fabric.

**Note**

- If the upper thread was incorrectly threaded, the upper thread may be too loose. In this case, refer to “Upper Threading” on page 26 and rethread the upper thread.

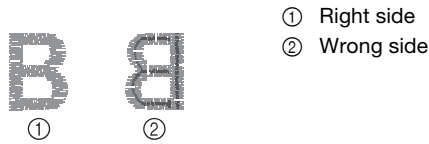

Touch **+** in **Tension** to tighten the upper thread tension. (The tension number will increase.)

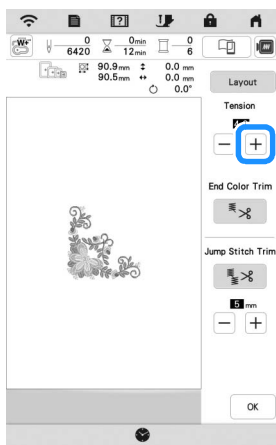

### Adjusting Overall Upper Thread Tension

When embroidering, if the overall tension of the upper thread is too tight or too loose, adjust it from the setting screen. The selected setting will be applied to all patterns. If an individual embroidery pattern needs additional fine tuning, refer to “Adjusting Thread Tension” on page 75.

- 1 Touch .  
→ The settings screen appears.
- 2 Touch .  
→ The embroidery settings screen appears.
- 3 Display [Embroidery Tension] in the embroidery settings screen.
- 4 Use **+** **-** to adjust the upper thread tension.
  - \* **+** : Tighten the upper thread tension.
  - \* **-** : Loosen the upper thread tension.



- 5 Touch **OK** .

### Adjusting the Bobbin Case

The bobbin case can be easily adjusted when bobbin tension changes are required to accommodate different bobbin threads. Refer to “Embroidering Attractive Finishes” on page 65.

To adjust the bobbin tension for embroidery function, using the bobbin case, turn the slotted screw (-) with a (small) screwdriver.

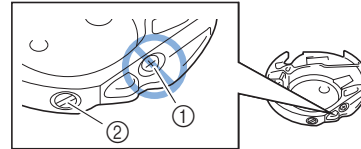

- 1 Do not turn a phillips screw (+).
- 2 Adjust with a screwdriver (small).

### Correct Tension

Upper thread slightly appears on the wrong side of fabric.



### Bobbin Thread Is Too Loose

Bobbin thread appears slightly on the right side of fabric.



If this occurs, turn the slotted screw (-) clockwise, being careful not to over-tighten the screw, approximately 30-45 degrees to increase bobbin tension.

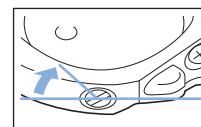

### ■ Bobbin Thread Is Too Tight

Upper thread on the right side of fabric seems to be lifting/looping and bobbin thread is not seen on the wrong side of fabric.

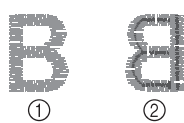

- ① Right side
- ② Wrong side

If this occurs, turn the slotted screw (-) counterclockwise, being careful not to over-loosen the screw, approximately 30-45 degrees to decrease bobbin tension.

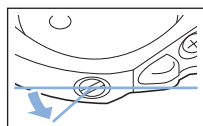



## IMPORTANT

- **DO NOT** adjust the position of the phillips (+) screw on the bobbin case as this may result in damage to the bobbin case, rendering it unusable.
- If the slotted screw (-) is difficult to turn, do not use force. Turning the screw too much or providing force in either (rotational) direction may cause damage to the bobbin case. Should damage occur, the bobbin case may not maintain proper tension.

#### 💡 Note

- When adjusting the bobbin case, be sure to remove the bobbin from the bobbin case.

## Using the Automatic Thread Cutting Function (End Color Trim)

The automatic thread cutting function  will cut the thread at the end of embroidering each color. This function is initially turned ON. To turn this function OFF, touch  and then .

- \* This setting returns to its default  when the machine is turned off.

1 Touch .

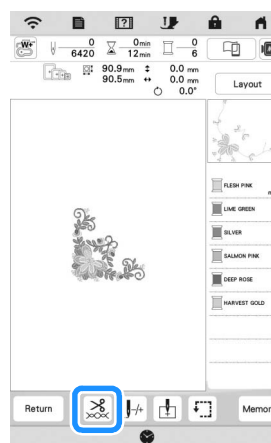

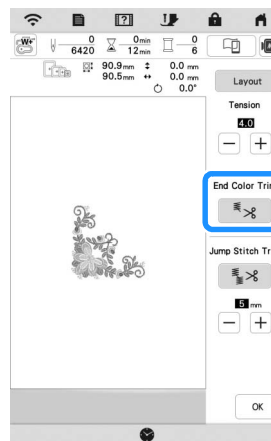

2 Touch  to turn off the automatic thread cutting function.



→ The key will display as . When one color thread is embroidered, the machine will stop without cutting the thread.



## Using the Thread Trimming Function (Jump Stitch Trim)

The thread trimming function  will automatically trim any excess thread jumps within the color. This function is initially turned ON. To turn this function OFF, touch  key and then .

\* Your customized setting remains after turning the machine off and on.

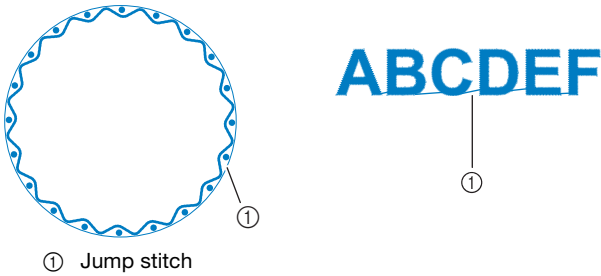

- 1 Touch .
- 2 Touch  to turn off the thread trimming function.

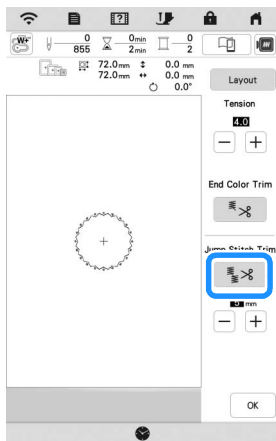

→ The key will display as . The machine will not trim the thread before moving to the next stitching.

### Selecting the Length Of Jump Stitch Not to Trim

When the thread trimming function  is turned on, you can select the length of the jump stitch.

Select a setting from 5 mm to 50 mm in 5 mm increments.

\* Your customized setting remains after turning the machine off and on.

Touch  or  to select the length of jump stitch.



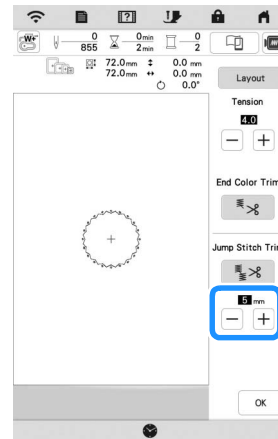

For example: Touch  to select 25 mm (approx. 1 inch) and the machine will not trim a jump stitch of 25 mm or less before moving to the next stitching.



### Note

- If design has many trims it is recommended to select a higher jump stitch trim setting in order to reduce the amount of excess tails on backside of fabric.
- The higher number of the jump stitch length selected, the fewer number of times the machine will trim. In this case, more jump stitches remain on the surface of the fabric.

## Adjusting the Embroidery Speed

- 1 Touch .
  - The settings screen appears.
- 2 Touch .
  - The embroidery settings screen appears.
- 3 Display [Max Embroidery Speed] in the embroidery settings screen.
- 4 Use   to change the maximum embroidery speed.

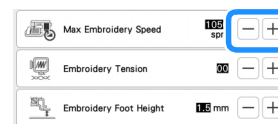

### Memo

- SPM is the number of stitches embroidered in one minute.
- Decrease the embroidery speed when embroidering on thin, thick, or heavy fabrics and when using a specialty thread like a metallic thread.
- The setting specified before the main power is set to OFF remains selected the next time that the machine is turned ON.

- 5 Touch .

## Changing the Thread Color Display

You can display the name of the thread colors or embroidery thread number.

### Memo

- Colors on the screen may vary slightly from actual spool colors.
- [Original], imported data remains the brand thread created with the software, is set as a default.



1 Touch .

→ The settings screen appears.



2 Touch .

→ The embroidery settings screen appears.

3 Display [Thread color] in the embroidery settings screen.

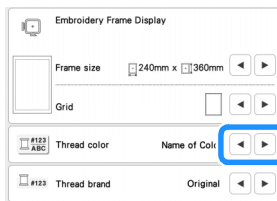
4 Use   to display the name of the thread colors or the embroidery thread number.



5 Use   to select a thread brand.

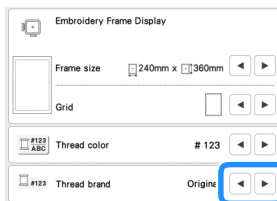

6 Touch .

## Aligning the Pattern and the Needle

**Example:** Aligning the lower left side of a pattern and the needle

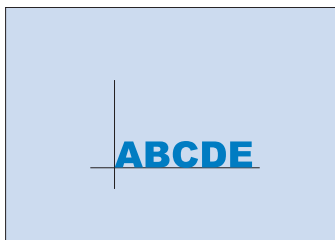

1 Mark the embroidery start position on the fabric, as shown.

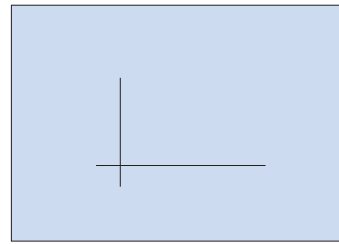

2 Touch .



3 Touch .

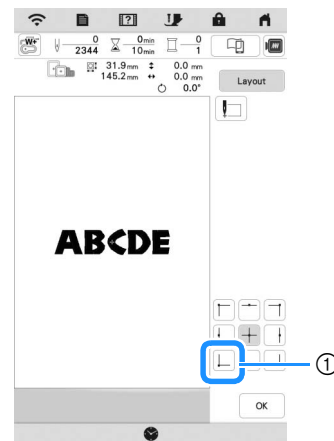

① Start position

→ The needle is positioned in the lower-left corner of the pattern. The carriage moves so that the needle is positioned correctly.

4 Touch .

5 Touch  and then, touch .

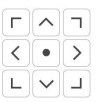
6 Use  to align the needle and the mark on the fabric, and start embroidering the pattern.

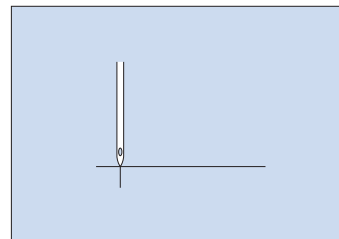

## Embroidering Linked Characters

Follow the procedure described below to embroider linked characters in a single row when the entire pattern extends beyond the embroidery frame.

**Example:** Linking "FG" to the characters "ABCDE"

# A B C D E F G

1 Select the character patterns for "ABCDE".

2 Touch .



3 Touch .

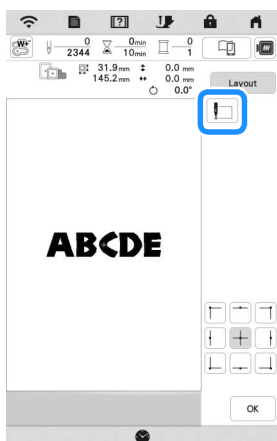

→ The needle is positioned in the lower-left corner of the pattern. The carriage moves so that the needle is positioned correctly. The machine is set to embroider until the first stitch of the next character pattern (F).

### Note

- To cancel the starting point setting and return the starting point to the center of the pattern, touch

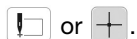



- Using  can select a different starting point for embroidering. However, the starting point setting is canceled.

4 Touch .

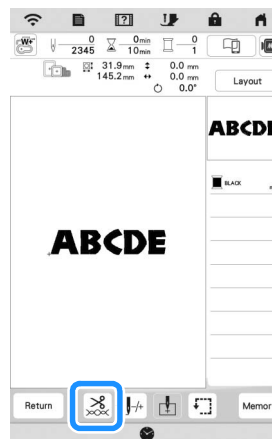
5 Touch .



6 Touch  to turn off the thread cutting function and then touch .



7 Press the "Start/Stop" button.

8 After the characters are embroidered, cut the threads to a generous length, remove the embroidery frame, reposition the fabric in the hoop so that the remaining characters ("FG") can be embroidered, and then attach the embroidery frame.

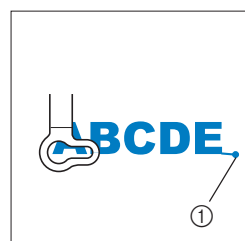

① End of the embroidering

9 As in step 1, select the character patterns for "FG".

10 Touch .

**11** Touch .

→ The needle is positioned in the lower-left corner of the pattern. The carriage moves so that the needle is positioned correctly.

**12** Touch , then  and use  to align

the needle with the end of embroidering for the previous pattern.



**13** Touch .

**14** Press the “Start/Stop” button to start embroidering the remaining character patterns.



## USING THE MEMORY FUNCTION

### Saving Embroidery Patterns

 **Note**

- Do not turn the main power to OFF while the [Saving...] screen is displayed. You will lose the pattern you are saving.

**1** Touch  when the pattern you want to save is in the embroidering screen.

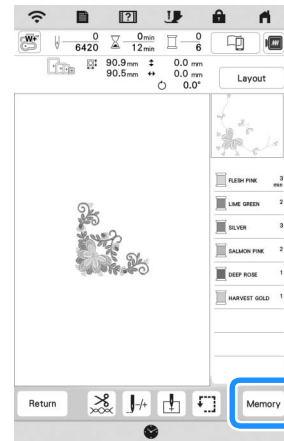

 **Memo**

- You can also save the pattern by touching  in the embroidery edit screen.

**2** When saving the embroidery pattern in a USB media, insert the USB media into the USB port on the machine.

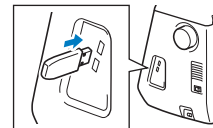

**3** Touch the desired destination to start saving.



- ① Save to the machine's memory.
- ② Save to the USB media. The pattern is saved in a folder labeled [bPocket].
- ③ Save to the wireless function pocket. For the detailed procedure, refer to the manual for PE-DESIGN (version 11 or later).

## Retrieving Embroidery Patterns

**1** When retrieving the embroidery patterns from a USB flash drive, insert the USB flash drive into the USB port on the machine.

To retrieve embroidery patterns via wireless network, use PE-DESIGN (version 11 or later) or Design Database Transfer to transfer the patterns in advance. For details on transferring embroidery patterns, refer to the manual for PE-DESIGN or Design Database Transfer.

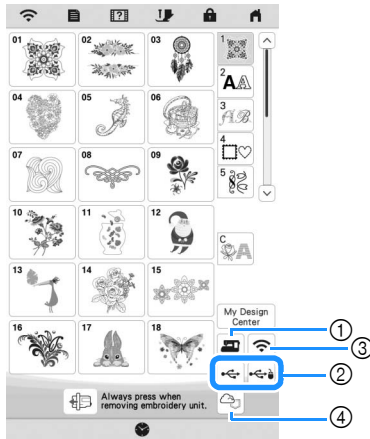

- ① Retrieve from the machine's memory.
- ② Retrieve from a USB media.
- ③ Retrieve the pattern via the wireless network connection. For detailed procedures, refer to PE-DESIGN manual (Version 11 or later).
- ④ Retrieve from Artspira App. (page 108)

## Memo

- If the embroidery pattern to be retrieved is in a folder of the USB media, touch the key for that folder. Touch to return to the previous screen.
- You can save all or multiple data to the machine by touching .

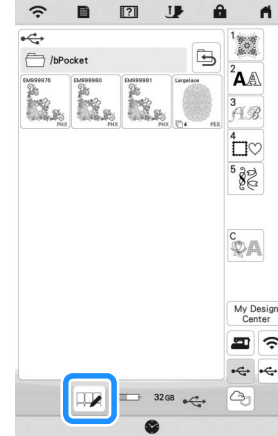

- To select multiple patterns, touch their thumbnails.
- : Select all patterns.
- : Deselect all patterns.
- : Save the selected patterns to the machine.
- \* To cancel the selection, touch again.

## 2 Touch .

- \* Touch to delete the embroidery pattern.

## EMBROIDERY APPLICATIONS

## Using a Frame Pattern To Make an Appliqué

**Note**

- If you change the size or position of the patterns when making an appliqué, make a note of the size and the location.

**Method 1**

You can use framed patterns of the same size and shape to create an appliqué. Embroider one pattern with a straight stitch and one pattern with a satin stitch.

- 1 Select a straight stitch frame pattern. Embroider the pattern onto the fabric for the appliqué piece, then cut neatly around the outside of the shape.

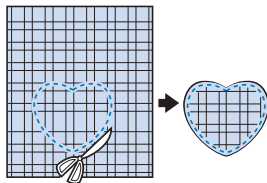
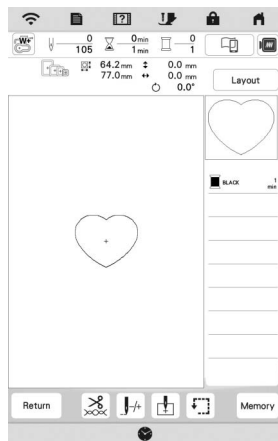

- 2 Embroider the same pattern from step 1 onto the base fabric.
- 3 Apply two-sided stabilizer material to the back of the fabric for the appliqué piece created in step 1. Attach the appliqué to the base fabric matching the shapes.

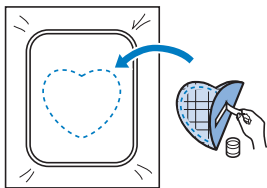

- 4 Select the satin stitch frame pattern of the same shape as the appliqué. Embroider over the fabric for the appliqué piece and base fabric from step 3 to create the appliqué.

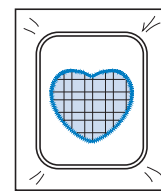
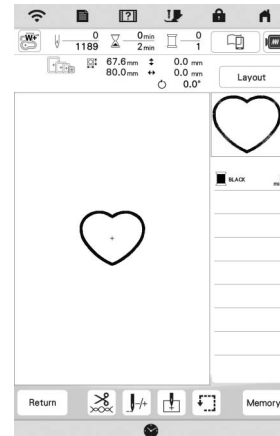
**Method 2**

- 1 Select a straight stitch frame pattern, and embroider the pattern onto the base fabric.

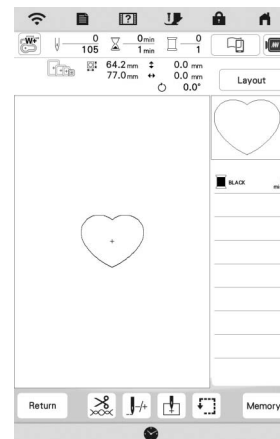

- 2 Place the fabric for the appliqué piece over the pattern embroidered in step 1 and embroider the same pattern on the fabric for the appliqué piece.

\* Be sure that the fabric for the appliqué piece completely covers the stitched line.

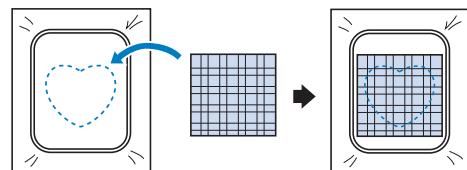

- Remove the embroidery frame from the embroidery unit, and cut around the outside of the stitches of the fabric for the appliqué piece. And then, reattach the embroidery frame to the embroidery unit.

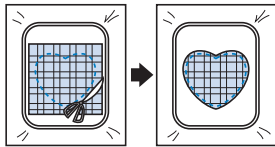

**Note**

- Do not remove the fabric from the embroidery frame to cut it. Also, do not pull or push on the fabric. Otherwise, the fabric may loosen in the frame.

- Select the satin stitch frame pattern of the same shape as the appliqué and embroider the satin stitch pattern to create an appliqué.

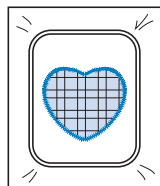
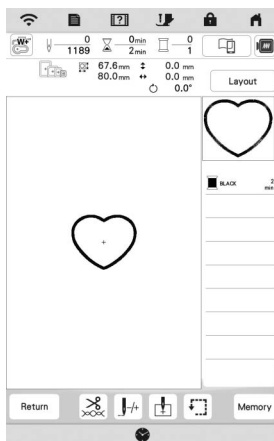

## Embroidering Couching Patterns

Couching patterns can be embroidered using yarn.



### CAUTION

- When using yarn, we recommend selecting yarn of weight 4 (MEDIUM (4)). Medium yarn is often referred to as worsted weight, 20 knitted stitches per 10 cm, or 9-11 wraps per inch. The diameter of the yarn is approximately 2-3 mm (approx. 1/12-1/8 inch). If the yarn is extremely thin or thick, has an unusual shape (flat or furry), or more than 2 yarns, the best finishing results may not be achieved, or injuries or damage may result.

**Note**

- If the spool stand in the procedure is not included with your machine, purchase the optional spool stand from your Brother authorized dealer or our web site <https://s.brother/coeka/>.
- Before embroidering your project, do trial embroidery on a scrap piece of fabric that is the same as that used in your project.

### ■ Preparing for Embroidery Couching

- Turn off the machine. Attach the embroidery unit.
- Install a bobbin wound with embroidery bobbin thread.
- Turn on the machine.
- Touch , and then touch .



5 Select the desired pattern from the desired category.

And then touch .

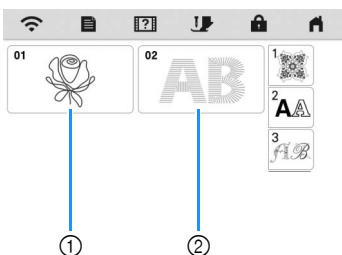

- ① Couching patterns
- ② Fill couching embroidery font

6 Touch  to lock all keys and buttons, and then raise the presser foot lever.

7 Attach embroidery couching foot "Y".

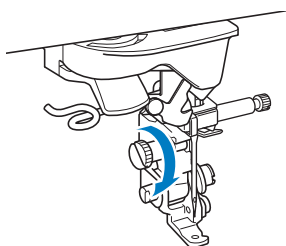

## ⚠ CAUTION

- When using the embroidery couching foot "Y", make sure the machine is in embroidery mode. Otherwise, the needle will strike the embroidery couching foot, causing the needle to break and possibly causing injury.

8 Rotate the handwheel and check that the needle is in the left half of the hole in embroidery couching foot "Y".

If the needle is not in the left half, use the disc-shaped screwdriver to turn the screw of embroidery couching foot "Y" to adjust the position of the embroidery foot. Turn the screw toward you to move the embroidery foot to the right. Turn the screw toward the back to move the embroidery foot to the left. After making adjustments, rotate the handwheel and check that the needle does not touch the presser foot.

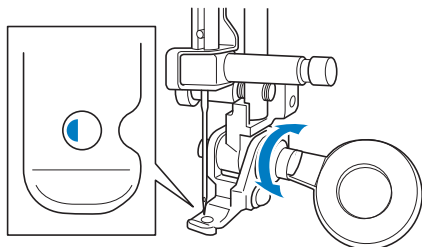

9 Attach the spool stand (sold separately) to the machine.

At this time, do not raise the telescopic thread guide shaft.

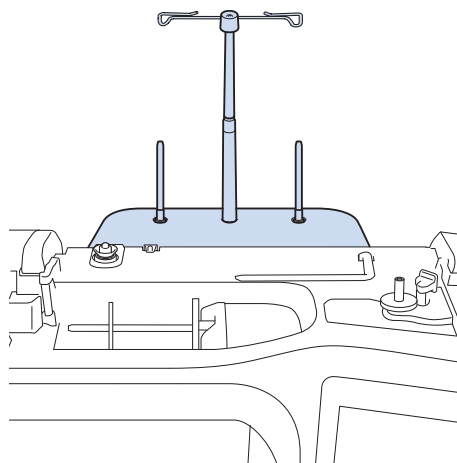

10 Insert the yarn guide for embroidery couching into the slot on the top left of the machine.

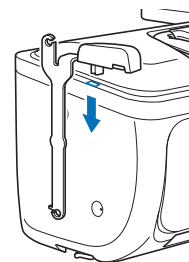

11 Pass the yarn through the telescopic thread guide and the yarn guide (①) to (②).

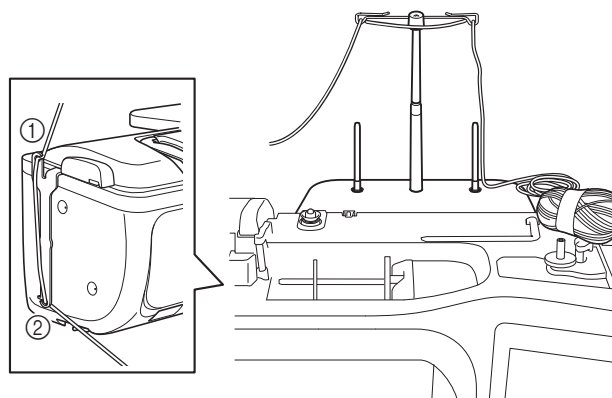

### Note

- Pull off an appropriate amount of yarn from the ball so that the yarn does not become taut.
- Make sure that the yarn does not become entangled as you work.



- 12 Pass the yarn through the guide on embroidery couching foot “Y”.

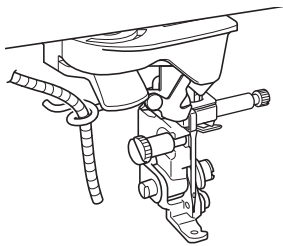

- 13 Thread the yarn through embroidery couching foot “Y”.  
Pass the yarn through the loop in the yarn threader, and then pass the threader from top to bottom through the hole in embroidery couching foot “Y”. Pull the yarn to the front of the machine.

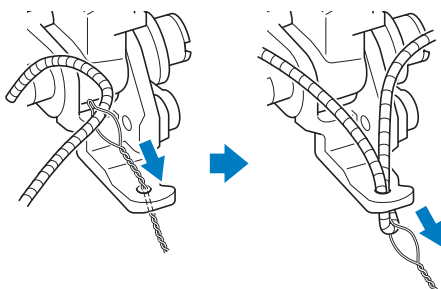

**Memo**

- Place a sheet of paper under the presser foot to smoothly pass the yarn threader through the hole in embroidery couching foot “Y”.

- 14 Touch  to unlock all keys and buttons.

- 15 Thread the machine with the upper thread.

**Note**

- Do not use the spool stand for upper thread. Otherwise thread may tangle with yarn.

**Memo**

- For best results, use an upper thread that is the same color as the yarn.

- 16 Press  (Presser foot lifter button) twice to raise the presser foot and then attach the embroidery frame to the embroidery unit.

**Embroidering a Couching Pattern**

- 1 Touch .

- 2 Make sure that about 20 cm (approx. 8 inches) of yarn is pulled to the front of the machine.

- 3 While holding the yarn in your hand in front of you, press the “Start/Stop” button.

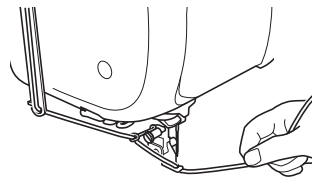

**CAUTION**

- Pulling the yarn upwards may cause it to catch on the needle, causing it to break. Be careful not to allow the yarn to catch on the needle.

**Note**

- Before embroidering, make sure that there is enough yarn, upper thread and bobbin thread.
- Make sure that the yarn passes smoothly through the guides. Unravel as much yarn from the ball as necessary so that the yarn does not become taut.
- Use yarn that has no knots.

- 4 After embroidering several stitches, release the yarn.

→ When embroidering is finished, the machine will automatically trim the threads and stop.

**Memo**

- When using a high-density yarn, the upper thread tension may be disturbed. If this happens, it is possible to improve it by raising the [Embroidery Foot Height] by about 1 mm on the settings screen.

- 5 Cut the yarn, leaving about 20 cm (approx. 8 inches).

- 6 Punch a hole through the fabric with an awl or tapestry needle and then use the yarn threader to pull the excess yarn to the wrong side of the fabric.

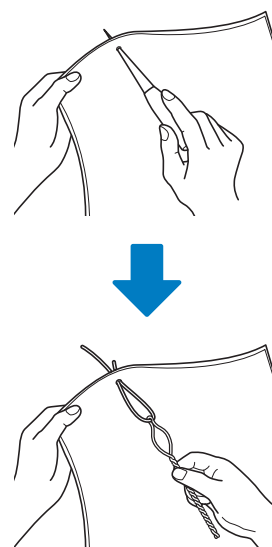

- 7 Tie the end of the yarn so it cannot be pulled out, and then use scissors to cut off any excess yarn.

## Creating Stippling, Echo Quilting, or Decorative Fill Patterns around a Design

Stippling, echo quilting, and decorative fill patterns can be created around the machine's built-in patterns or original embroidery data without using My Design Center.

### Memo

- If this simple stippling operation is used with batting sandwiched between two layers of fabric, the embroidery pattern and stippling may become misaligned.

Stippling can be added in My Design Center after the pattern is embroidered. For details, refer to "Decorative Stitching around a Pattern in Embroidery (a Quilting Function)" on page 104.

### 1 Select the pattern that stippling will be added around.

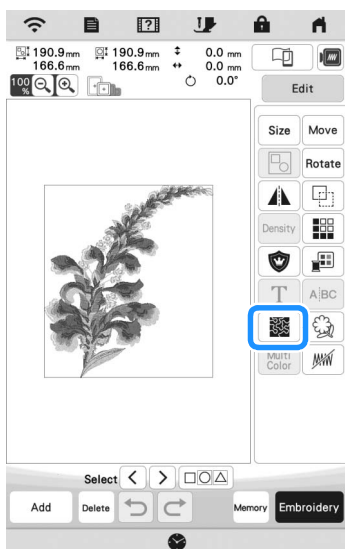

- \* To select multiple patterns, refer to "Selecting Multiple Patterns at the Same Time" on page 38.

### 2 Touch in the embroidery edit screen.





→ Stippling is automatically applied around the selected pattern.

### 3 After specifying the stitch settings for the stippling,

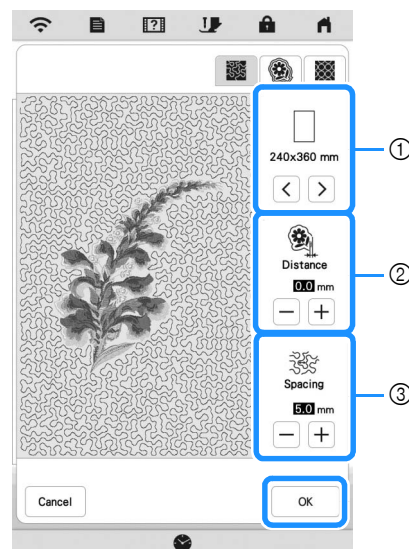
touch  , and then touch .



- ① The stippling is added within the area of the selected frame size. If the pattern is larger than the selected frame size, the area indicating the frame size will appear in gray, and stippling will not be added.
- ② Specify the distance from the outline of the pattern to the stippling.
- ③ Specify the spacing for the stippling.

- \* Touch  in the stippling settings screen to create an echo quilting pattern.
- \* Touch  in the stippling settings screen to create a decorative fill pattern.

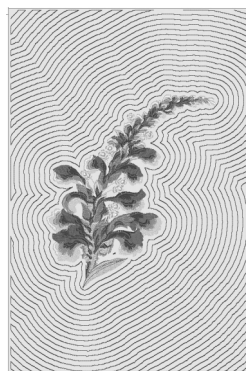

①



②

- ① Echo quilting pattern
- ② Decorative fill pattern

## Embroidering Split Embroidery Patterns

Split embroidery patterns created with PE-DESIGN Ver. 7 or later can be embroidered. With split embroidery patterns, embroidery patterns larger than the embroidery frame are divided into multiple sections, which combine to create a single pattern after each section is embroidered.

For details on creating split embroidery patterns and for more detailed embroidery instructions, refer to the Instruction manual included with PE-DESIGN Ver. 7 or later.

- 1 Insert the USB media containing the created split embroidery pattern, and then select the split embroidery pattern to be embroidered. (page 82)

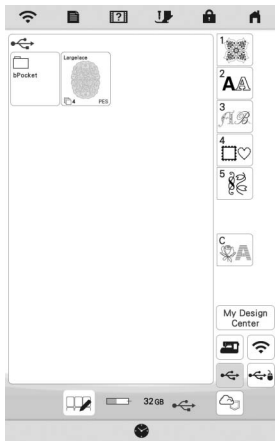

- 2 Select section 001 to be embroidered.

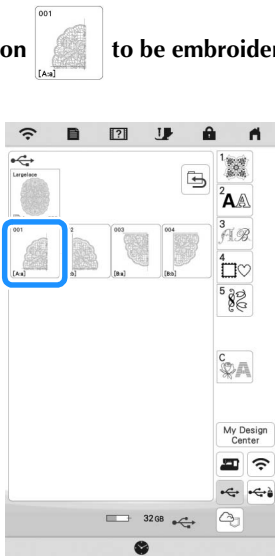

- 3 Touch **Set**.

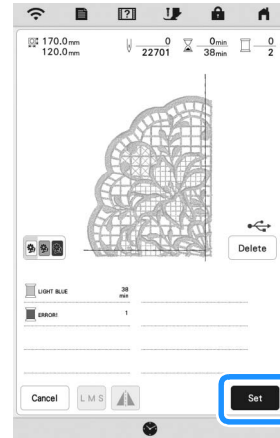

- 4 If necessary, touch **Edit** and edit the pattern.

Touch **Embroidery** to display the embroidery screen.

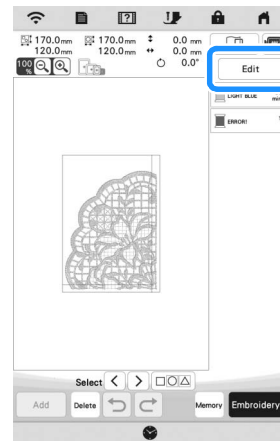

- 5 Embroider the pattern section.

- 6 When embroidering is finished, the following screen appears. Touch **OK**.

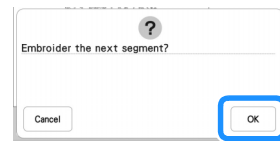

→ A screen appears so that a section of the split embroidery pattern can be selected.

- 7 Repeat steps 2 through 6 to embroider the remaining sections of the pattern.

# Chapter 4 MY DESIGN CENTER

## ABOUT MY DESIGN CENTER

With My Design Center, you can use the functions listed below:

- Hand-drawn functions - creating embroidery patterns by drawing on the LCD screen
- Loading functions - creating embroidery patterns by transferring data from the application or USB media.

You can also combine patterns that you have created with the machine's built-in patterns.

Start My Design Center by touching  in the home page screen or touching  in the embroidery pattern selection screen.

## PATTERN DRAWING SCREEN

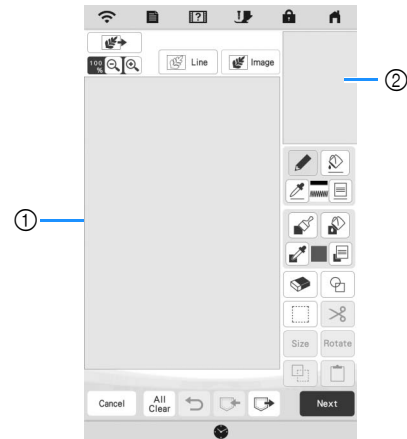

- ① Pattern drawing area
- ② Pattern preview area

### Memo

- The actual dimension of the pattern area is the size of the embroidery frame, which is shown in the pattern preview area. The pattern you drew may be bigger than you expected. Please resize the pattern after converting the design to the embroidery pattern.
- When the pattern is enlarged so that only a part of it appears in the pattern drawing area, the entire pattern is displayed in the pattern preview area. The red frame in the pattern preview area indicates the part of the pattern displayed in the pattern drawing area. Move the red frame in the pattern preview area with the touch pen (stylus) or your finger to display the corresponding area in the pattern drawing area.

■ Key Functions

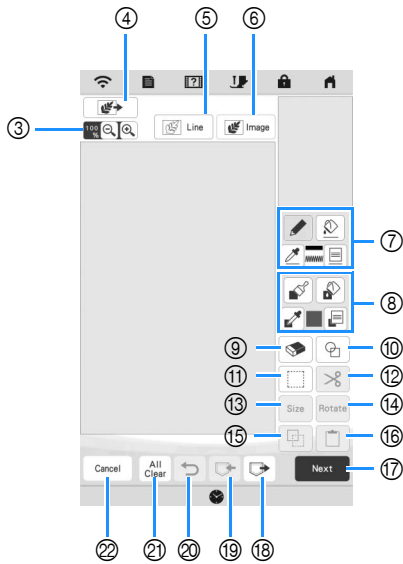



No.	Display	Explanation	Page
	Name		
③		Magnify the pattern.	92
	Magnify key		
④		Load the fabric as the background or the picture as the reference when creating the pattern. You can load the image file from the application or USB media.	97
	Load key		
⑤		Load a line drawing, then edit and convert it to embroidery data. You can load a line drawing from the application or USB media to create the embroidery design.	98
	Line design key		
⑥		Load an image, then edit and convert it to embroidery data. You can load an image from the application or USB media to create the embroidery design.	100
	Image design key		
⑦		Draw lines and set the color. You can select the line type, stitch type and color as you need.  Touch  to pick up the color, line type and stitch type from a line in the pattern within the pattern drawing area. The picked up color is shown as the currently selected line color beside the button and as the selected color in the Line Property screen.	91
	Line tool key		
⑧		Paint with brush and set the color. You can select the brush type, fill type and color as you need. Painted lines and regions will be converted to the pattern to be embroidered with fill stitch.  Touch  to pick up the color, brush type and fill type from a region in the pattern within the pattern drawing area. The picked up color is shown as the currently selected region color in the color bar and the Region Property screen.	92
	Brush tool key		

No.	Display	Explanation	Page
	Name		
⑨		Erase lines and shapes that have been drawn. You can select the size/shape of the eraser.	94
	Erase key		
⑩		Select the stamp shape for pattern drawing.	93
	Stamp key		
⑪		Select a section for moving, copying, deleting, changing size and rotating lines and shapes that have been drawn.	94
	Select key		
⑫		Cut out the selected section.	—
	Cut key		
⑬		Change the size of the selected section.	102
	Size key		
⑭		Rotate the selected section.	—
	Rotate key		
⑮		Duplicate the selected section. The temporarily positioned section can immediately be rotated, enlarged, reduced or moved.	—
	Duplicate key		
⑯		Paste in the selected section duplicated with the duplicate key or a selected section using the cut key.	—
	Paste key		
⑰		Proceed to the stitch settings screen.	—
	Next key		
⑱		Recall image data created with My Design Center from the machine's memory or the USB media.	—
	Recall key		
⑲		Store the pattern being created to the machine's memory or the USB media.	—
	Memory key		
⑳		Undo the last operation that was performed and return to the previous state. Each touch of this key will undo one operation.	—
	Undo key		
㉑		Clear all the lines and shapes and start from the beginning. The background image is also cleared.	—
	All Clear key		
㉒		Exit from My Design Center. All lines and shaped are erased when you touch this key.	—
	Cancel key		

## Before Creating Designs

The pattern preview displays the design smaller than the actual size. You can view the actual pattern size by setting the [Embroidery Frame Display].

With [Embroidery Frame Display] in the settings screen, the embroidery frame and grid can be specified separately.

- 1 Touch  .  
→ The settings screen appears.
- 2 Touch  .  
→ The embroidery settings screen appears.
- 3 Display [Embroidery Frame Display] in the embroidery settings screen.
- 4 Select the embroidery frame display.

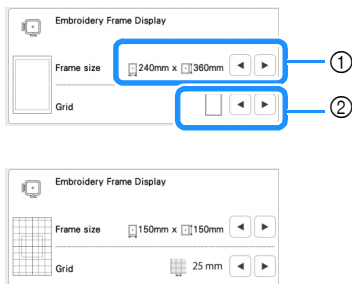

- ① Embroidery frame types
- ② Grid types

## Drawing Lines

- 1 Touch  and draw lines.

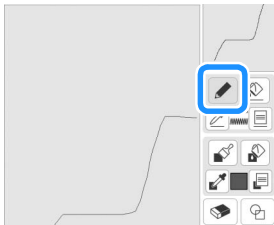

### Memo

- When  is touched, all regions will be displayed in the background to clarify the drawing lines on the screen.

## Setting the Line Types, Stitch Types and Colors

You can set or change the line types, stitch types and colors anytime. You can also specify the line types, stitch types and colors before drawing lines.

- 1 Touch  to set the line types, stitch types and colors.

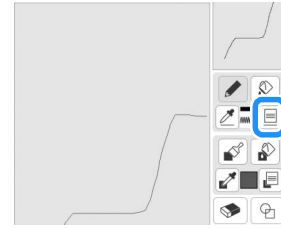



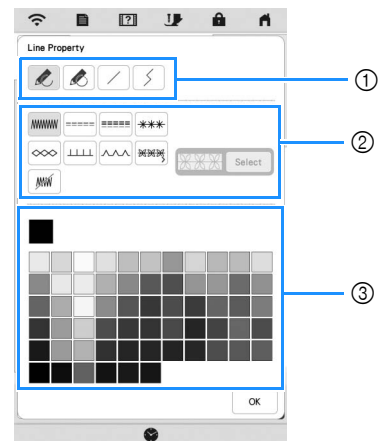

→ The settings screen appears.



- ① Line types
- ② Stitch types
- ③ Line color selection: touch the color palette to activate the drawing pen color.

### Line types

	Freehand line with the end open.
	Freehand line closing the end automatically.
	Straight line with one stroke
	Straight line changing directions to the point you select. If the end point is created near the start point, a closed object will be created.

Stitch types

	Zigzag stitch
	Running stitch
	Triple stitch
	Candlewicking stitch
	Chain stitch
	E stitch
	V stitch
	Select motif stitches Displays motif stitch selection screen, where  can be touched to select a pattern.
	Line without stitch for creating a region. Created region will be defined by the gray line.

2 Touch to return to the pattern drawing screen.

→ You can check the selected stitch type and color.



- ① Color bar
- ② Stitch type

3 Touch then touch on the line to change its color.

→ The connected line will be changed to the selected color.

**Memo**

- Touch to magnify the image when you cannot touch on the line correctly.
- Touch , and then select a color within the pattern drawing area to apply the same color to other lines or parts of the pattern.

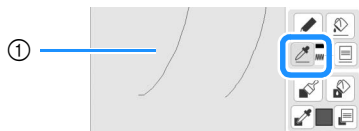

① Use to select the line color.

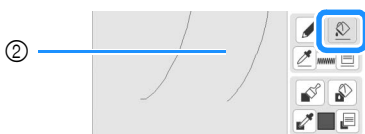

② Touch for changing the line color, and then select the pattern to be changed.

Drawing Regions

1 Touch and draw with brush.



■ Setting the Brush Types, Fill Patterns and Fill Colors

1 Touch to set the brush types, fill patterns and fill colors.

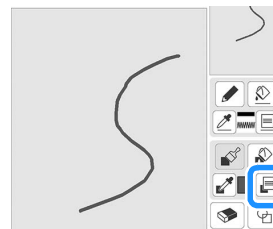

→ The setting screen appears.

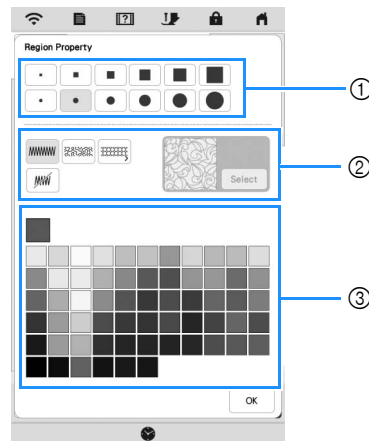

- ① Brush types
- ② Fill stitch types
- ③ Fill color selection: touch the color palette to activate the paint brush color.

Brush shapes/sizes



Fill stitch types

	Fill stitch pattern
	Stippling pattern



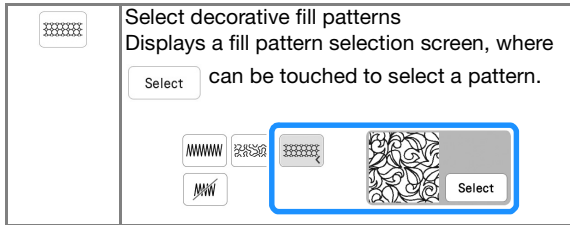

Select decorative fill patterns  
Displays a fill pattern selection screen, where  
Select can be touched to select a pattern.

Select when you don't want fill stitch.

**2** Touch to return to the pattern drawing screen.

→ The color bar on the brush tool key is changed to the selected color. If a stippling pattern or decorative fill pattern has been selected, the stitch pattern is displayed.

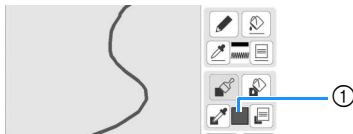

① Color bar

**3** Touch and touch on the brush line to change color and fill stitch type. You can also set the fill color, stitch type and fill pattern of a closed area made of the lines and brush lines.

**Memo**

- Touch to magnify the image when you cannot touch on the fill correctly.
- Touch , and then select a pattern color in the pattern drawing area to apply that fill color and stitch type to other patterns.

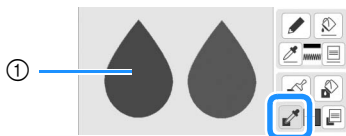

① Use to select the fill color.



② Touch for changing the fill color and stitch type, and then select the pattern to be changed.

## Using the Stamp Key

**1** Touch .



**2** Select a stamp type and stamp shape.

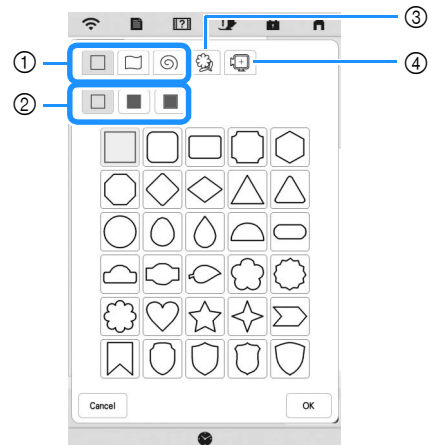

- ① Stamp shapes
- ② Stamp types
- ③ Saved outlines
- ④ Frame embroidering areas

### Stamp shapes

	Basic shapes
	Closed shapes
	Open shapes

### Stamp types (Only for Basic shapes)

	Outline
	Fill stitch
	Outline and fill stitch

\* Select the outline () , fill stitch () , or outline and fill stitch () of a basic shape.



Saved outlines

	Embroidery pattern outlines can be registered as stamp shapes. When registering stamp shapes, select from the last 20 embroidery patterns used. If more than 20 shapes are registered, the oldest one is automatically erased. For details on registering a stamp shape, refer to “Decorative Stitching around a Pattern in Embroidery (a Quilting Function)” on page 104.
---	--

Frame embroidering areas

	Select an embroidering area in order to arrange the pattern to fit an embroidery frame.
---	---

\* Touch  to return to the pattern drawing screen.

**3** Touch  to set the selected stamp.

→ The pattern drawing screen appears.

\* You can change size of, rotate or move the shape right after you create it by touching  or .

Using the Erase Key

**1** Touch .

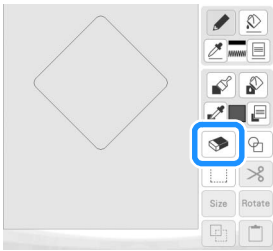

**2** Select the shape of the eraser.

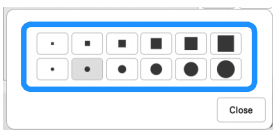

→ The pattern drawing screen appears.

**3** Drag along the area or line that you want to erase while the key appears as .

Using the Select Key

You can select the part of the design to move and/or edit. Some keys are available only after you select the part.

**1** Touch .

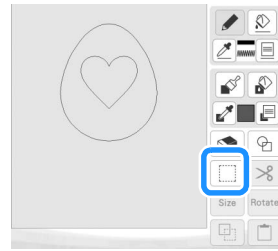

**2** Select the area you want to edit.

\* Drag to create the red box around your selected area to be edited.

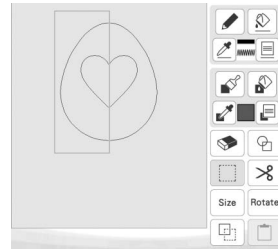

**3** Edit the design with available keys. (Refer to “Key Functions” on page 90 for the details of each key function.)

**4** Touch , and then specify the stitch setting.

# STITCH SETTINGS SCREEN

After creating the pattern drawing data (.pm9) in the drawing screen (page 89), you will have an opportunity to:

- Check and change the stitch settings for each line and region.
- Save the pattern drawing data (.pm9).
- Convert the data to an embroidery pattern (.phx), proceed to the embroidery edit screen, and/or save the embroidery pattern.

## Specifying Individual Stitch Settings

Select a pattern in the stitch settings screen to specify its line and region stitch settings. If multiple patterns are selected, the settings are applied to those patterns.

### Line Settings

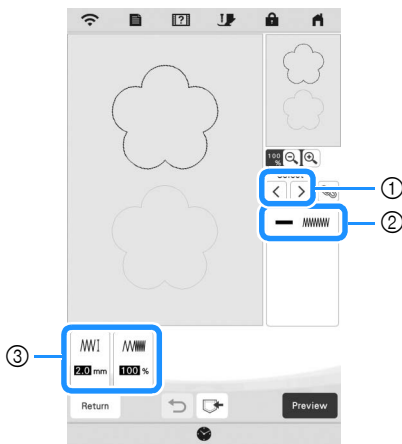

- 1 Select the line to be changed.
- 2 Shows the stitch type and color for the selected line.
- 3 Shows the stitch settings for the selected line.

### Line stitch settings

Select the type of stitching you want applied to your line art.

#### Zigzag stitch

[Zigzag width]	Specifies the width of the stitch.
[Density]	Specifies the density of the stitch.

#### Running stitch / Triple stitch

\* Both includes an under sewing.

[Run Pitch]	Specifies the length of the stitch.
-------------	-------------------------------------

#### Candlewicking Stitch

[Size]	Increases/reduces the size of the stitch.
[Spacing]	Specifies the spacing of the stitch.

#### Chain stitch

[Size]	Increases/reduces the size of the stitch.
[Thickness]	Sets repeated embroidering at the same part.

#### E stitch

[Stitch width]	Increases/reduces the size of the pattern.
[Spacing]	Specifies the spacing of the E stitch.
[Thickness]	Sets repeated embroidering at the same part.
[Flip]	Specifies if the decorative line shows up inside or outside.

#### V stitch

[Stitch width]	Increases/reduces the size of the pattern.
[Spacing]	Specifies the spacing of the V stitch.
[Thickness]	Sets repeated embroidering at the same part.
[Flip]	Specifies if the decorative line shows up inside or outside.

#### Motif stitch



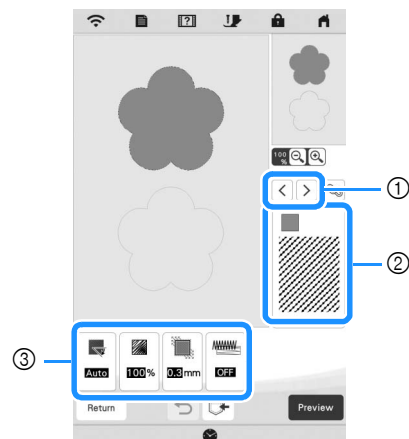

[Size]	Increases/reduces the size of the pattern.
[Spacing]	Specifies the spacing of the motif stitch.
[Flip]	Specifies if the decorative line shows up inside or outside.

### Region Settings





- 1 Select the region to be changed.
- 2 Shows the stitch type and color for the selected region.
- 3 Shows the stitch settings for the selected region.



**Fill stitch settings** 

 [Direction]	Specifies the embroidering direction. Select <b>Manual</b> to change to the desired direction of fill stitch.
 [Density]	Specifies the stitch density of fill stitch.
 [Pull compensation]	Specifies to correct the shrinkage of the pattern by slightly shortening or lengthening the stitching. Change the setting after you test embroider the pattern and can check the shrinkage.
 [Under sewing]	Select if you need or do not need the under sewing for the stabilized fabric.



**Stippling stitch settings** 

 [Run Pitch]	Specifies the length of a stitch of the stippling stitch.
 [Spacing]	Specifies the spacing between the stitches when embroidering the stippling stitch.
 [Distance]	Specifies the offset from the pattern outline.

**Decorative fill stitch settings** 

 [Size]	Increases/reduces the size of the pattern.
 [Direction]	Specifies the rotation angle of the pattern.
 [Outline]	Select whether [ON] or [OFF] the outline is also converted to embroidery data. If [ON] is selected, the number of thread jumps can be reduced.

1 Use   to select the line or region to be changed.



→ Each touch of   moves the highlighting of the selected pattern in order.

2 Select the setting to be changed, and then change the setting in the screen that appears. (In this example, the embroidering direction will be changed.)

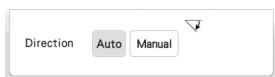

→ The setting screen appears.



3 Touch **Manual**, and then use   to change the direction.

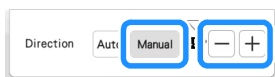



4 Touch **Set** to apply the setting.

- \*  appears on the tab for settings that were changed.
- \* Change other settings in the same way.

**Specifying Global Stitch Settings**

The same stitch settings can be changed at the same time for multiple patterns of the same type.

1 Use   to select the stitch whose settings are to be changed, and then touch .

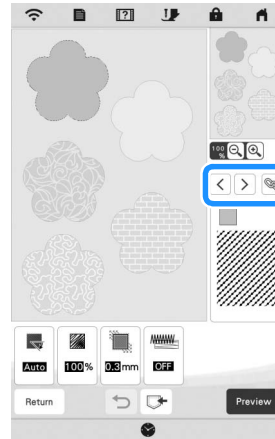

→ The same stitch type lines or regions will be selected at the same time.

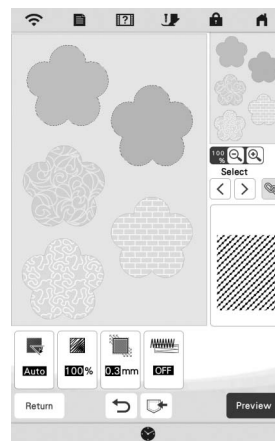

2 Follow steps 2 through 4 in “Specifying Individual Stitch Settings” on page 95 to change the settings.

3 Touch **Preview** to create the embroidery pattern.

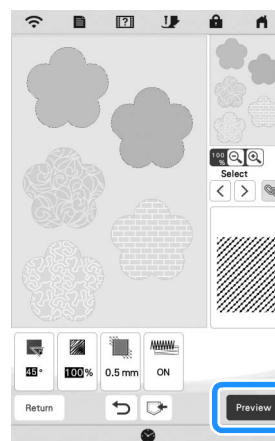

→ When the following message appears, touch .

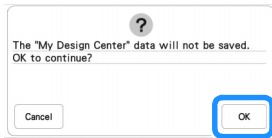

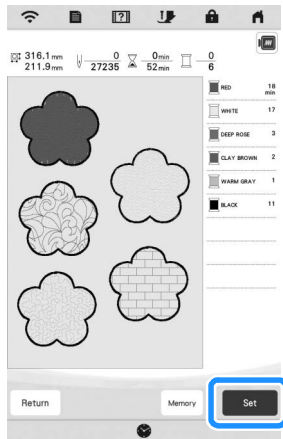

**4** Touch  to display the pattern editing screen.

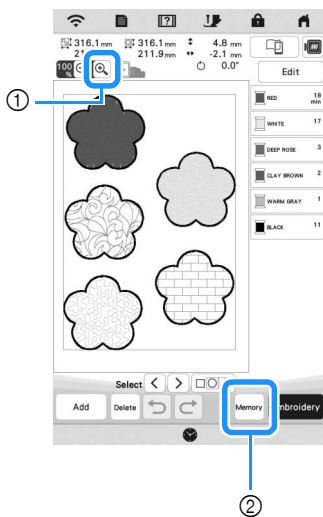
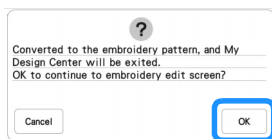

→ When the following message appears, touch .



- ①  : Check an enlarged view of the pattern.
- ②  : Save the embroidery data.

## Loading the Background Image

Prepare the data file of your favorite picture so that you can create an embroidery pattern. Load the image file from the application “MY DESIGN SNAP APP” on page 107 or a USB media.

**1** Touch .



**2** Select the device you saved the data to.



**3** Select the data, and then touch .

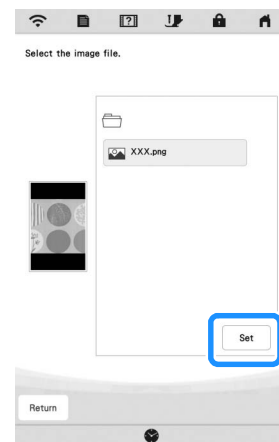

**4** The selected image is displayed transparently in the pattern drawing area.





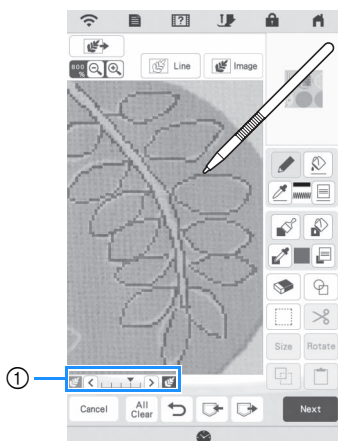

**5** Using the included touch pen (stylus), touch , and then draw lines to trace the image.

\* For details on drawing lines, refer to “Drawing Lines” on page 91.



① Transparency adjustment

\* Touch  or  to adjust the transparency of the background.

Each touch of  lightens the background, making the line pattern darker. Each touch of  darkens the background, making the line pattern lighter.

**6** After editing the pattern, touch  to specify the settings for pattern.

**7** Touch  to create the embroidery pattern.

## LINE CONVERSION

Custom patterns can be created from drawings. You can create patterns by loading an image on the application “MY DESIGN SNAP APP” on page 107 or a USB media.

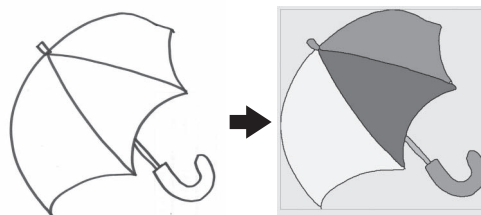

### Recommended line drawings for Line Conversion

- Line drawings must be drawn clearly using lines with approximately 1 mm thickness.
- Line drawings should be drawn in a strong contrast.
- If the lines are too short or gathered too densely, they will not be loaded correctly.

 **Note**

- For details on creating patterns using color illustrations, refer to “ILLUSTRATION CONVERSION” on page 100.
- If you cannot convert the drawings as expected, you can edit the design in My Design Center. Refer to “PATTERN DRAWING SCREEN” on page 89.
- Line drawings are converted without recognizing the thickness of lines. If you want to change the thickness of lines, specify in the settings screen. Refer to “STITCH SETTINGS SCREEN” on page 95.
- Line drawings are converted as black lines. If you want to change the colors, specify in My Design Center. Refer to “Drawing Lines” on page 91.

## Create a Pattern with Line Conversion

**1** Touch .

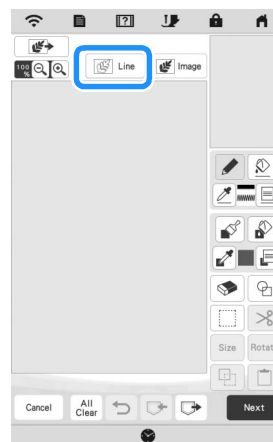

→ The image display screen appears.

**2** Select the device you saved the data to.



**3** Select the data, and then touch **Set**.

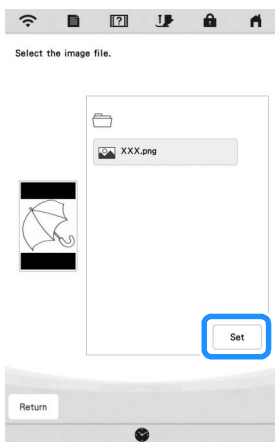

**4** When loading is finished, specify the [Gray-Scale Detection level] on the screen if necessary.

The [Gray-Scale Detection level] can change the black and white threshold for the image.



- \* If you do not know how the settings should be changed, first continue the operation without specifying settings and check the results.
- \* To stop loading and return to the screen in step **2**, touch **Cancel**. The loaded image will be deleted when you return to the previous screen.

**5** Move  to frame the image for the pattern.

**6** Touch **OK**.

→ The screen for confirming the converted image appears.

**7** In the screen for confirming the converted image, you can adjust the [Gray-Scale Detection level] again, if necessary.

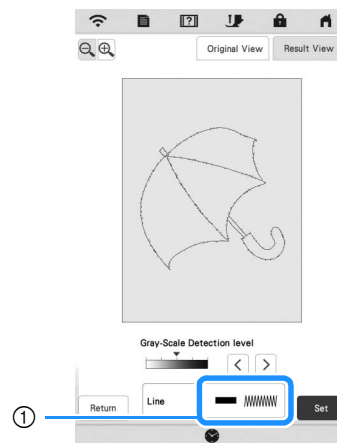

① The settings for the lines to be embroidered appear.

\* If you do not know how the settings should be changed, first continue the operation without specifying settings and check the results.

\*  : Enlarge the image.

\* **Original View** : Display the image before being converted. Compare the images before and after being converted, and then change the settings if necessary.

\* **Return** : Return to the previous screen.



→ After changes to the settings for [Gray-Scale Detection level] are applied, **Set** changes to **Retry**. Touch **Retry** to check that the image is as desired.

**8** Touch **Set**.

→ The pattern drawing screen appears.

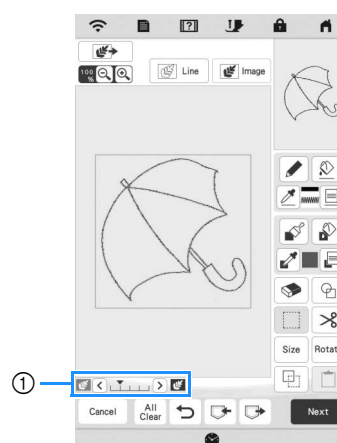
**9** If necessary, edit the loaded image.



\* After the loaded image is converted to stitching, it appears as a background in the pattern drawing screen. Use gauge ① to adjust the transparency of the background. Each touch of  lightens the background, making the line pattern darker. Each touch of  darkens the background, making the line pattern lighter.

# ILLUSTRATION CONVERSION

Custom patterns can be created from color illustrations. You can create patterns by loading an image on the application "MY DESIGN SNAP APP" on page 107 or a USB media.

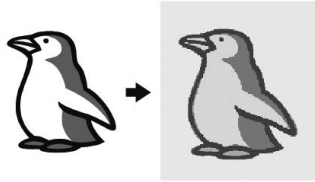

### Recommended illustrations for Illustration Conversion

- Illustrations that are clearly drawn, with no gradation, fading or blurriness.
- Illustrations that are at least a 5 mm square
- Illustrations that are extremely simple images

## Create a Pattern with Illustration Conversion

1 Touch Image .

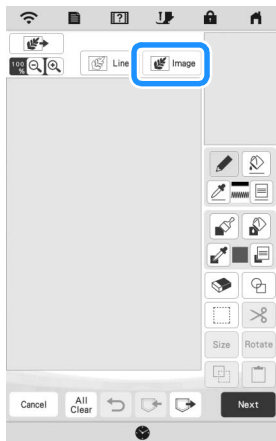

→ The image display screen appears.

2 Select the device you saved the data to.



3 Select the data, and then touch .



4 When loading is finished, specify the necessary settings in the loaded image confirmation screen.

Change the settings to adjust the image so it can easily be converted to the desired pattern.

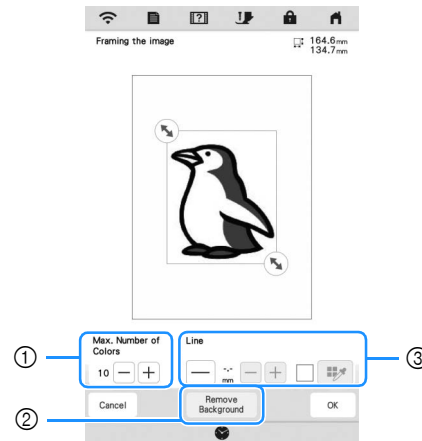

①	[Max. Number of Colors]	The number of colors in an image will be reduced less than the number specified here, and then the outline will be extracted.
②	[Remove Background]	Select whether or not the background color will be included as one of the colors.
③	[Line]	Select whether or not the outline will be detected as a line. A thick outline can also be detected as a region. When detected as a line, the line thickness and color can be specified.



\* To stop loading and return to the screen in step 2, touch .



## Memo

- Touch  to detect the outline.  
Line thickness can be specified from 1.0 mm (approx. 1/16 inch) to 5.0 mm (approx. 3/16 inch).



- Touch  to select the outline color. Select by touching the color, or moving  icon using



in the color selection screen.





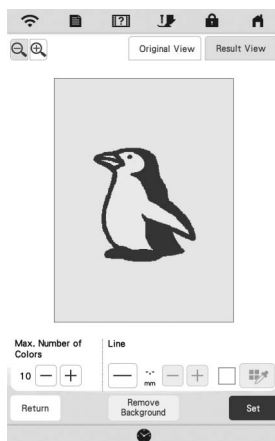

- 5 Move  to frame the image for the pattern.

- 6 Touch .

→ The screen for confirming the converted image appears.

- 7 In the screen for confirming the converted image, adjust the image as necessary as in step 4.





- \*  : Enlarge the image.
  - \*  : Display the image before being converted. Compare the images before and after being converted, and then change the settings if necessary.
  - \*  : Return to the previous screen.
- After changes to the settings described above have been applied,  changes to . Touch  to check that the image is as desired.

- 8 Touch .

→ The pattern drawing screen appears.

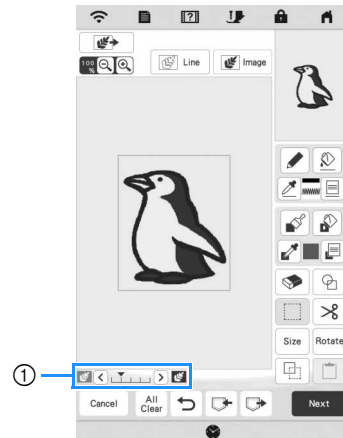
- 9 If necessary, edit the loaded image.



- \* After the loaded image is converted to stitching, it appears as a background in the pattern drawing screen. Use gauge ① to adjust the transparency of the background. Each touch of  lightens the background, making the illustration pattern darker. Each touch of  darkens the background, making the illustration pattern lighter.



# STIPLING

## Basic Stippling with My Design Center

Create a stippling design with the basic procedure.

**Example:**



**Note**

- You can load a line drawing to create a stippling stitch or use image design function of a fabric pattern and incorporate the stippling stitch.

**1** Touch  .

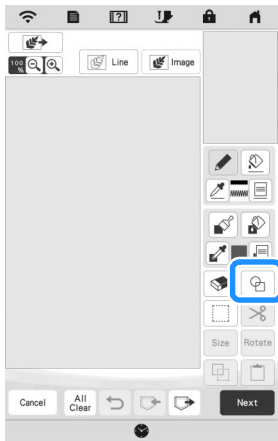

**2** Select the square shape, and then touch  .

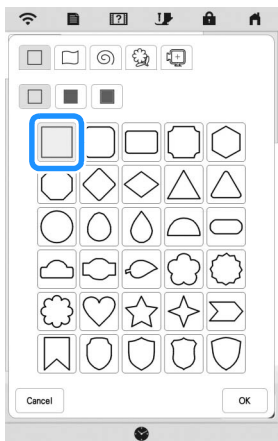

**3** Touch  .

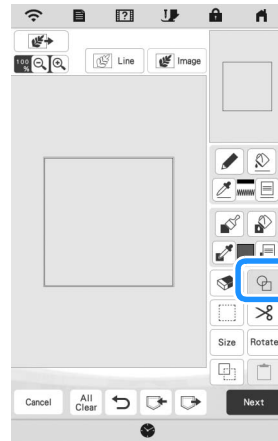

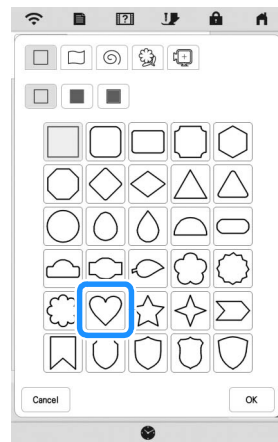

**4** Select the heart shape, and then touch  .



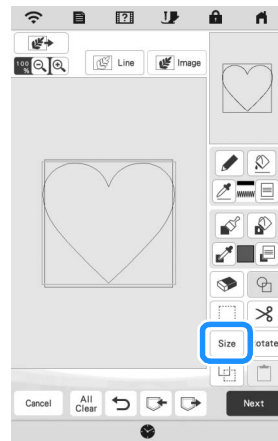

**5** Touch  .

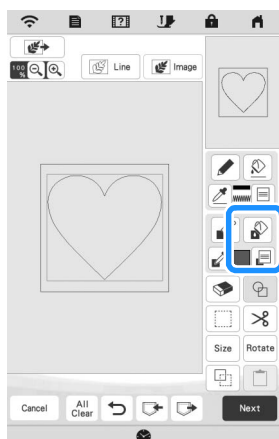

6 Touch  until the heart shape fits in the square shape, and then touch .

7 Touch , and then touch .



8 Touch , and then select the stitch color. Touch  after setting the color.

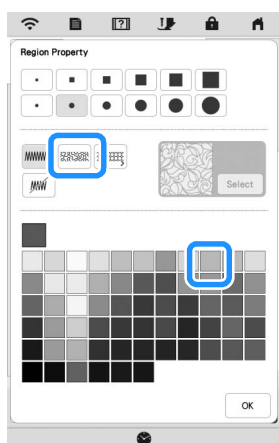

9 Select the region you want to set stippling effect.

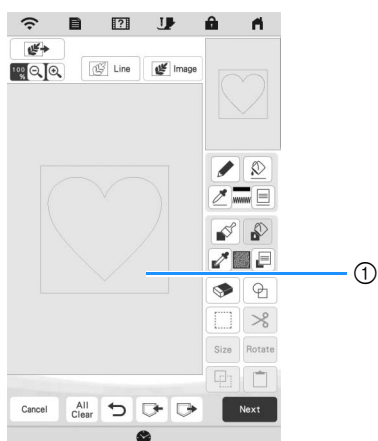

① Select this region.

10 Touch .

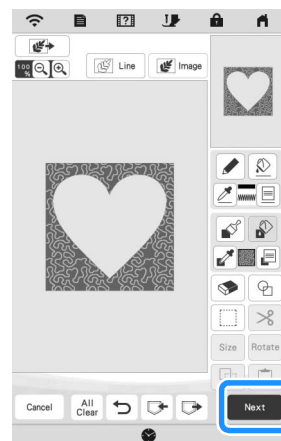

11 Adjust the stippling stitch settings to create the desired effect, and then touch .

\* For details, refer to "Specifying Individual Stitch Settings" on page 95.

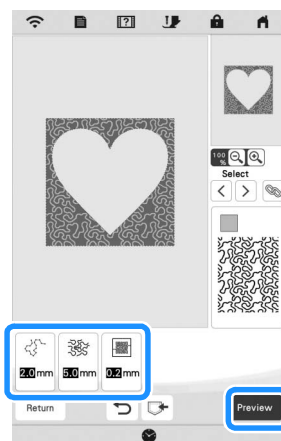

→ When the following message appears, touch .



12 Touch **Set** to convert into embroidery.

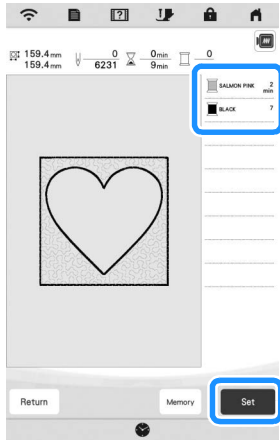

→ When the following message appears, touch **OK**.

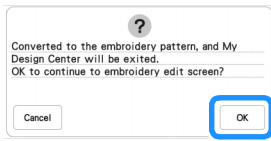



13 Follow the procedure described on “EDITING PATTERNS” on page 39 to edit the pattern as desired.

## Decorative Stitching around a Pattern in Embroidery (a Quilting Function)

### Memo

- For best results, reduce the embroidery speed. (page 14)
- For best results, hoop the stabilizer and fabric and embroider the design prior to adding the batting and backing under the hoop for quilting.

A quilt can be created with stippling stitch around an embroidery pattern.

1 Touch  in the home page screen and select the pattern that decorative stitching will be added around, and then touch  in the embroidery edit screen.

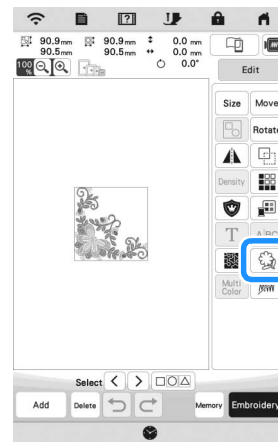

→ The outline of the pattern is displayed.

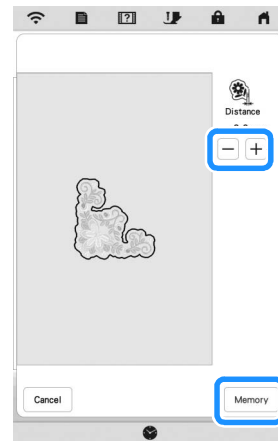

2 Set the distance and touch **Memory**.





→ A message appears, and the pattern outline is registered as a stamp shape in My Design Center.

Touch **OK**.



- 3 Touch **Embroidery** to continue to the embroidery screen, and then embroider the pattern at the center.
- 4 Remove the embroidery frame from the carriage.
- 5 Photograph the embroidery frame with the application.
- 6 Attach the embroidery frame to the carriage again.
- 7 Place the batting and bottom layer of fabric under the embroidery frame.
- 8 Touch  in the home page screen to start My Design Center.
- 9 Touch  to load the embroidered fabric. Refer to “Loading the Background Image” on page 97 for details.



- 10 Touch , touch  to recall the stamp shape registered in step 2, and then arrange it over the loaded pattern.

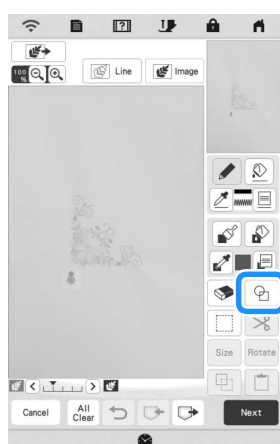

- 11 Use a stamp or rectangular frame to determine the region to be stitched.

#### Note

- If the region is to be drawn by hand, be sure to draw a completely closed shape. If the region is not closed, it will not be correctly closed with any of the fill stitches.







- 12 Touch  to select the pattern and color of the decorative stitching.

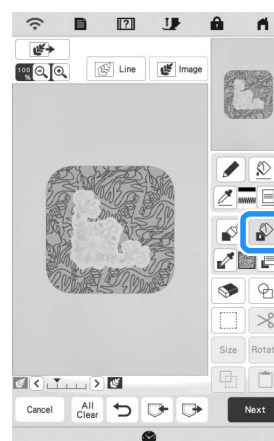

- 13 Touch , and then fill the region to be stitched outside of the stamp shape outline.





- 14 If you select the stamp shapes to determine the region on step 11, touch  for the line tool keys to select . Touch , then select the frame outline, and then touch .

\* Stitch settings can be adjusted in the stitch settings screen. For details, refer to "STITCH SETTINGS SCREEN" on page 95.

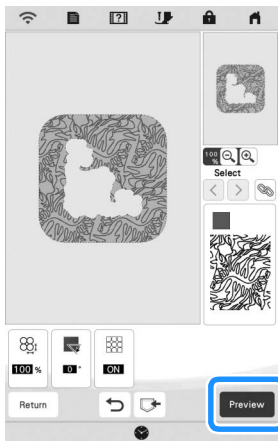

- 15 Specify the stitch spacing and length in the stitch settings screen, and then touch .



→ Check the pattern, and then touch .



- 16 Embroider the stippling stitch around the embroidery pattern.

## MY STITCH MONITOR APP

With the My Stitch Monitor App installed on your smart device and the machine and smart device connected to the same wireless network, you can check the operating status of the machine. In addition, you can receive notifications when the machine stops.

### ■ Installing the App

- 1 Use your smart device to scan the appropriate QR code below to visit Google Play™ or the App Store.



Android™: <https://s.brother/msmagi>



iOS: <https://s.brother/msmggi>

- 2 Install [My Stitch Monitor].



My Stitch Monitor

### Memo

- To download and install the app, you can also search for [My Stitch Monitor] in Google Play™ or the App Store.
- For more information on how to use this application, visit the following web site. <https://s.brother/cpeag/>

## ■ Monitoring

### Memo

- The app will be updated from time to time. The following descriptions may differ from the actual screens and operations.

- 1 **Connect the machine to your wireless network.**
    - \* Refer to "WIRELESS NETWORK CONNECTION FUNCTIONS" on page 18.
  - 2 **Confirm that your smart device and your machine are connected to the same network.**
  - 3 **Tap the icon for [My Stitch Monitor] on the smart device to start the app.**
  - 4 **Follow the instructions that appear in the app to connect the app to your machine.**
    - \* Select the name that appears beside [Machine name] in the settings screen on your machine.
- The machine can now be monitored.

## MY DESIGN SNAP APP

With My Design Snap app, you can position your embroidery designs on the fabric, by capturing image of the hooped fabric and sending the image to your machine.

### ■ Installing the My Design Snap App

- 1 **Use your smart device to scan the appropriate QR code below to visit Google Play™ or the App Store.**



Android™: <https://s.brother/mdsgfi>



iOS: <https://s.brother/mdsafi>

- 2 **Install [My Design Snap].**



My Design Snap

### Memo

- To download and install the app, you can also search for [My Design Snap] in Google Play™ or the App Store.
- For more information on how to use this application, visit the following web site.  
<https://s.brother/cpeag/>

## ARTSPIRA APP COMPATIBLE

Functions have been added for the Artspira App. With these functions, you can transfer content published on the app to the embroidery machine and enjoy creating original works using the functions on the app.

For more information about the app, refer to the official website. For details on how to operate the embroidery machine using the app, see the Artspira Quick Guide on Artspira support page (<https://s.brother/csyai/>).

# Chapter 5 APPENDIX

## CARE AND MAINTENANCE

### ⚠ CAUTION

- Be sure to unplug the machine before cleaning it. Otherwise, injury may result.

### Cleaning the LCD

If the surface of the LCD is dirty, lightly wipe it with a soft dry cloth.

### Cleaning the machine surface

When wiping dirt off the machine, firmly wring a soft cloth soaked in (lukewarm) water.

After cleaning the machine, dry it with a soft, dry cloth.

### Restrictions on Oiling

In order to prevent damaging this machine, it must not be oiled by the user. This machine was manufactured with the necessary amount of oil applied to ensure correct operation, making periodic oiling unnecessary.

If problems occur, such as difficulty turning the handwheel or an unusual noise, immediately stop using the machine, and contact your authorized Brother dealer or the nearest Brother authorized service center.

### Precautions on Storing the Machine

Do not store the machine in any of the locations described below, otherwise damage to the machine may result, for example, rust caused by condensation.

- \* Exposed to extremely high temperatures
- \* Exposed to extremely low temperatures
- \* Exposed to extreme temperature changes
- \* Exposed to high humidity or steam
- \* Near a flame, heater or air conditioner
- \* Outdoors or exposed to direct sunlight
- \* Exposed to extremely dusty or oily environments

#### 💡 Note

- In order to extend the life of this machine, periodically turn it on and use it. Storing this machine for an extended period of time without using it may reduce its efficiency.

### Cleaning the Race

- 1 Press  (Needle position button) to raise the needle.
- 2 Turn the main power to OFF, and then unplug the machine.
- 3 Remove the needle and embroidery foot (page 29, page 111).
- 4 Remove the bobbin cover.
- 5 Slide the needle plate cover toward you to remove it.

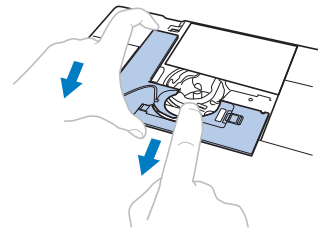

#### 💡 Note

- If the embroidery unit is attached, the needle plate can be removed when the bobbin cover is removed.

- 6 Grasp the bobbin case, and then gently lift out.

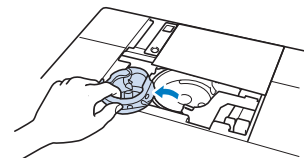

- 7 Use the cleaning brush or a vacuum cleaner to remove any lint and dust from the race and bobbin thread sensor and the surrounding area.

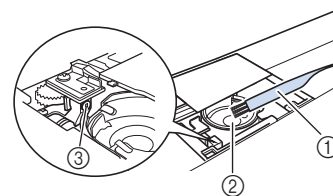

- ① Cleaning brush
- ② Race
- ③ Bobbin thread sensor

### IMPORTANT

- Do not apply oil to the bobbin case.



**Memo**

- If lint or dust collects on the bobbin thread sensor, the sensor may not operate correctly.

**8** Insert the bobbin case so that the ▲ mark on the bobbin case aligns with the ● mark on the machine.

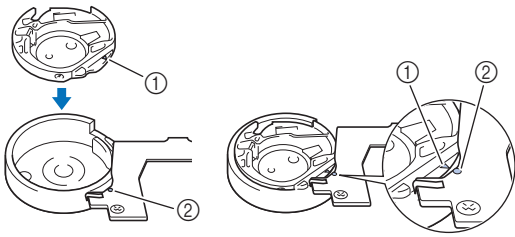

\* Align the ▲ and ● marks.

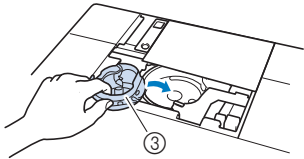

- ① ▲ mark
- ② ● mark
- ③ Bobbin case

\* Make sure that the indicated points are aligned before installing the bobbin case.

**CAUTION**

- Never use a bobbin case that is scratched or has a burr on it. Otherwise the upper thread may become tangled, and the needle may break and cause injury. For a new bobbin case, contact your nearest Brother authorized service center.
- Be sure that the bobbin case is correctly installed, otherwise the needle may break and cause injury.

**9** Insert the tabs on the needle plate cover into the needle plate, and then slide the cover back on.

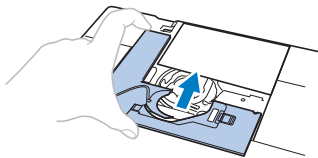

**10** Reattach the bobbin cover.

**Cleaning the Cutter in the Bobbin Case Area**

The cutter below the needle plate should be cleaned. If dust or lint accumulate on the cutter, it will be difficult to cut the thread when  (Thread cutter button) is pressed or the automatic thread cutting function is used. Clean the cutter when the thread is not easily cut.

**1** Follow steps **1** through **5** in “Cleaning the Race” to remove the needle plate cover.

**2** Use the screwdriver included with the machine to unscrew and remove the needle plate.

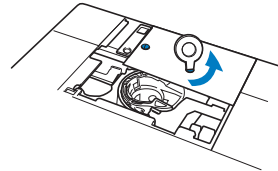

**3** Use the cleaning brush or a vacuum cleaner to remove any lint and dust from the cutter in the bobbin case area.

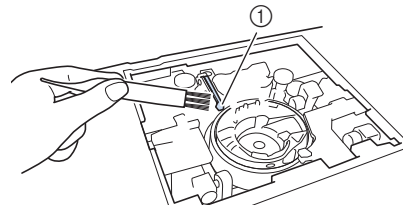

① Cutter

**CAUTION**

- Do not touch the cutter, otherwise injuries may result.

**4** Align the two screw holes in the needle plate with the two holes at the needle plate mounting base, and then fit the needle plate onto the machine.

**5** Lightly finger-tighten the screw on the right side of the needle plate. Then, use the screwdriver included to firmly tighten the screw on the left side. Finally, firmly tighten the screw on the right side.

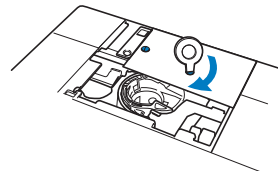

**6** Replace the bobbin case and the needle plate cover following steps **8** through **10** in “Cleaning the Race”.

## Changing Embroidery Foot “W+” with LED Pointer

### ⚠ CAUTION

- When attaching an embroidery foot, always touch  on the screen. You may accidentally press the “Start/Stop” button and possibly cause injury.
- Be sure to use the embroidery foot “W+” with LED pointer when doing embroidery. Using another embroidery foot may cause the needle to strike the embroidery foot, causing the needle to break and possibly causing injury.

1 Press  (Needle position button) to raise the needle.

2 Touch  to lock all keys and buttons.

- \* If the message [OK to automatically lower the presser foot?] appears on the LCD screen, touch

 to continue.

#### Note

- Before replacing the needle, cover the hole in the needle plate with fabric or paper to prevent the needle from falling into the machine.

3 Raise the presser foot lever.

4 Remove the connector of the embroidery foot “W+” with LED pointer from the connector on the back of the machine.

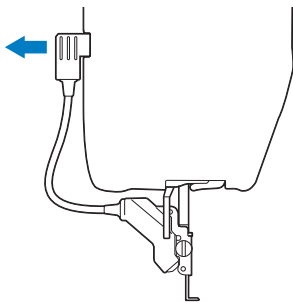

5 Use the included disc-shaped screwdriver to loosen the screw for the embroidery foot, and then remove the embroidery foot “W+” with LED pointer.

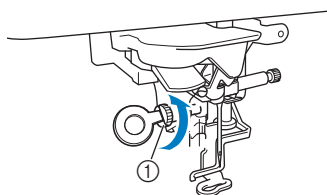

① Screw for embroidery foot

6 Position the embroidery foot “W+” with LED pointer on the presser foot bar by aligning the notch of the presser foot to the large screw.

Side view

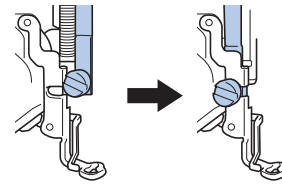

7 Hold the embroidery foot in place with your right hand, and then use the disc-shaped screwdriver to securely tighten the screw for the embroidery foot.

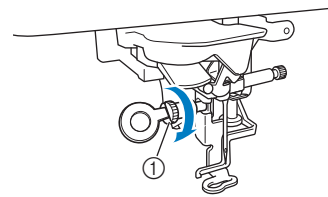

① Screw for embroidery foot

### ⚠ CAUTION

- Use the disc-shaped screwdriver to firmly tighten the screw for the embroidery foot. If the screw is loose, the needle may strike the embroidery foot and break, possibly cause injury.

8 Plug the connector of the embroidery foot “W+” with LED pointer into the jack on the back left side of your machine.

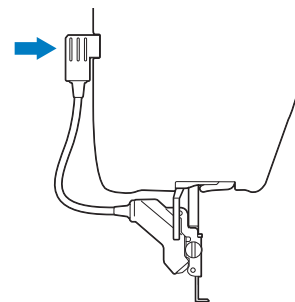



9 Touch  to unlock all keys and buttons.

- All keys and operation buttons are unlocked, and the previous screen is displayed.

## BEFORE LENDING OR DISPOSING OF THE PRODUCT

Please be sure to reset the settings of your machine to delete the following data.

- all saved data
- customized settings
- network information

**1** Touch , and then touch  beside [Reset to Default].

**2** Touch .

**Note**

- Do not turn the main power to OFF while the [Deleting...] screen is displayed.

## ADJUSTING THE SCREEN

### Touch Panel is Malfunctioning

If the screen does not respond correctly when you touch a key (the machine does not perform the operation or performs a different operation), follow the steps below to make the proper adjustments.

**1** Holding your finger on the screen, turn the main power switch to OFF and back to ON.



→ The touch panel adjustment screen appears.

**2** Using the included touch pen, lightly touch the center of each +, in order from 1 to 13.

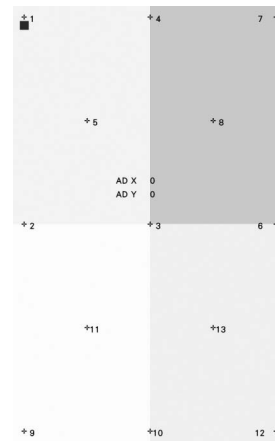

**Note**

- Only use the included touch pen to touch the screen. Do not use a mechanical pencil, pin, or other sharp object. Do not press too hard on the screen. Otherwise, damage may result.

**3** Turn the main power to OFF, then turn it back to ON.

**Note**

- If you finish the screen adjustment and the screen still does not respond, or if you cannot do the adjustment, contact your authorized Brother dealer.

## TROUBLESHOOTING

If the machine stops operating correctly, check the following possible problems before requesting service. You can solve most problems by yourself. If you need additional help, the Brother Support website offers the latest FAQs and troubleshooting tips.

Visit us at <https://s.brother/cpeag/>.

If the problem persists, contact your authorized Brother dealer or the nearest Brother authorized service center.

### If the Thread Becomes Tangled Under the Bobbin Winder Seat

If the bobbin winding starts when the thread is not passed through the pretension disk correctly, the thread may become tangled beneath the bobbin winder seat.

Wind off the thread according to the following procedure.

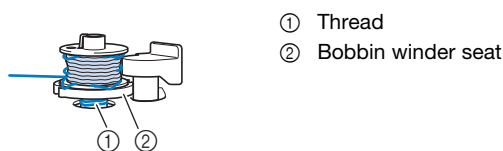

## ⚠ CAUTION

- Do not remove the bobbin winder seat even if the thread becomes tangled under the bobbin winder seat. The cutter in the bobbin winder seat may cause injury.

- 1 Touch **Stop** to stop the bobbin winding.



- 2 Cut the thread with scissors near the pretension disk.

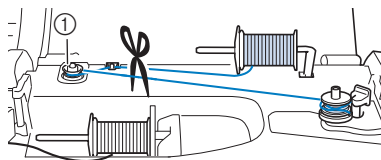

- ① Pretension disk

- 3 Push the bobbin winder switch to the right, and then remove the bobbin from the shaft and cut the thread leading to the bobbin in order to be able to completely remove the bobbin from shaft.

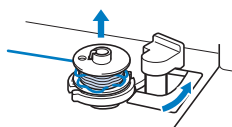

- 4 Hold the thread end with your left hand, and wind off the thread clockwise from under the bobbin winder seat with your right hand as shown below.

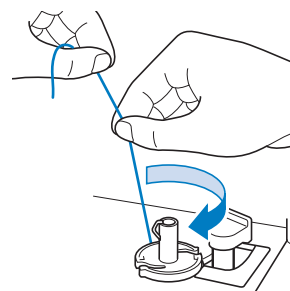

### List of Symptoms

Check the following possible problems before requesting service. If the reference page is “\*”, contact your authorized Brother dealer or the nearest Brother authorized service center.

#### ■ Getting Ready

Symptom, Cause/solution	Reference
<b>Cannot thread the needle.</b>	
Needle is not in the correct position. <ul style="list-style-type: none"> <li>Press  (Needle position button) to raise the needle.</li> </ul>	10
Needle is installed incorrectly.	29
Needle is turned, bent or the point is dull.	29
Upper threading is incorrect.	26
The needle threader hook is bent and does not pass through the eye of the needle.	*
The needle threader lever cannot be moved or returned to its original position.	*
A size 65/9 needle is being used. <ul style="list-style-type: none"> <li>The needle is incompatible with the needle threader. Manually pass the thread through the eye of the needle.</li> </ul>	28

#### Cannot lower the presser foot with the presser foot lever.

Presser foot was raised using  (Presser foot lifter button). <ul style="list-style-type: none"> <li>Press  (Presser foot lifter button) to lower the presser foot.</li> </ul>	10
---	----

#### Bobbin thread does not wind neatly on the bobbin.

The thread is not passed through the bobbin winding thread guide correctly.	23
Bobbin spins slowly.	23
The thread that was pulled out was not wound onto the bobbin correctly.	23

Symptom, Cause/solution	Reference
The empty bobbin was not set on the pin properly.	22



While winding the bobbin, the bobbin thread was wound below the bobbin winder seat.	
You have not wound the bobbin thread properly when you initially wound thread on the bobbin. Ensure that the bobbin thread was properly set in the guides.	22

The bobbin thread cannot be pulled up.	
Needle is turned, bent or the point is dull.	29
Bobbin is set incorrectly.	25

Machine does not operate	
All keys and buttons have been locked by  .	29, 111

Nothing appears in the LCD.	
Main power switch is not turned on.	10
The plug of the power cord is not inserted into an electrical outlet.	11

The LCD screen does not look very clear.	
The brightness of the screen is not adjusted.	13

Nothing happens, even if the LCD display is touched	
Adjust the screen.	112
The screen has been locked. <ul style="list-style-type: none"> <li>Touch either of the following keys to unlock the screen.  </li> </ul>	—

The LCD screen is fogged up.	
Condensation has formed on the LCD screen. <ul style="list-style-type: none"> <li>After a while, the cloudiness will disappear.</li> </ul>	—

Embroidery unit does not operate.	
Embroidery unit is not attached correctly.	31
Embroidery frame was attached before the unit was initialized.	31

Symptom, Cause/solution	Reference
Pointer of the embroidery foot “W+” with LED pointer does not indicate the position correctly	
With thick elastic fabric, the position will be misaligned only at raised parts in the fabric.	57
With fabric having a very uneven surface, the position is not correctly aligned. <ul style="list-style-type: none"> <li>The pointer indication should be used only as a reference.</li> </ul>	—

■ While Operating

Symptom, Cause/solution	Reference
Machine does not operate.	
“Start/Stop” button was not pressed.	10
There is no pattern selected.	33
Presser foot is not lowered.	10

Needle breaks.	
Needle is installed incorrectly.	29
Needle clamp screw is not tightened.	29
Needle is turned or bent.	29
Using improper needle, thread or the fabric prepared insufficiently for embroidering.	29, 53, 65
Upper thread tension is too tight.	75
Fabric is pulled during embroidering.	—
Spool cap is set incorrectly.	26
There are scratches around the opening in the presser foot.	*
There are scratches on the bobbin case.	*
Needle is defective.	29
A bobbin designed specifically for this machine is not used.	22
Upper threading is incorrect.	26
Bobbin is set incorrectly.	25
Presser foot is attached incorrectly.	111
Stabilizer is not attached to fabric being embroidered.	53
Bobbin thread is incorrectly wound.	22

Upper thread breaks.	
Machine is not threaded correctly (used the wrong spool cap, spool cap is loose, the thread did not catch the needle bar threader, etc.)	26
Knotted or tangled thread is being used.	—
Upper thread tension is too tight.	75

Symptom, Cause/solution	Reference
Thread is twisted.	—
Needle is turned, bent or the point is dull.	29
Needle is installed incorrectly.	29
There are scratches around the opening in the presser foot.	*
There are scratches on the bobbin case.	*
Using improper needle or thread for the selected fabric.	29
A bobbin designed specifically for this machine is not used.	22

#### The thread is tangled on the wrong side of the fabric.

Upper threading is incorrect.	26
Using improper needle or thread for the selected fabric.	29

#### The upper thread is too tight.

The bobbin thread is incorrectly installed.	25
---	----

#### Bobbin thread breaks.

Bobbin is set incorrectly.	25
Bobbin thread is incorrectly wound.	22
There are scratches on the bobbin or it doesn't rotate properly.	25
Thread is twisted.	—
A bobbin designed specifically for this machine is not used.	22

#### Fabric puckers.

There is a mistake in the upper or bobbin threading.	25, 26
Spool cap is set incorrectly.	26
Using improper needle or thread for the selected fabric.	29
Needle is turned, bent or the point is dull.	29
Thread tension is set incorrectly.	75

#### The pattern is not embroidered correctly.

The thread tension is incorrect.	75
The thread is tangled, for example, in the bobbin case.	109

#### Skipped stitches

Machine is threaded incorrectly.	26
----------------------------------	----

Symptom, Cause/solution	Reference
Using improper needle, thread or the fabric prepared insufficiently for embroidering.	29, 53, 65
Needle is turned, bent or the point is dull.	29
Needle is installed incorrectly.	29
Needle is defective.	29
Dust or lint has collected under the needle plate.	109
<b>Not embroidering</b>	
Needle is turned, bent or the point is dull.	29
Bobbin is set incorrectly.	25
Upper threading is incorrect.	26

#### High-pitched sound while embroidering

Pieces of thread are caught in the race.	109
Upper threading is incorrect.	26
A bobbin designed specifically for this machine is not used.	22
There are needle holes or friction scratches in the bobbin case.	109

#### The needle contacts the needle plate.

The needle clamp screw is loose.	29
Needle is turned, bent or the point is dull.	29

#### The handwheel feels sluggish when it is turned.

Thread is tangled in the bobbin case.	109
---------------------------------------	-----

### ■ After Embroidering

Symptom, Cause/solution	Reference
<b>Thread tension is incorrect.</b>	
Upper threading is incorrect.	26
Bobbin is set incorrectly.	25
Using improper needle, thread or the fabric prepared insufficiently for embroidering.	29, 53, 65
Thread tension is set incorrectly.	75
Bobbin thread is incorrectly wound.	22
Needle is turned, bent or the point is dull.	29
A bobbin designed specifically for this machine is not being used.	22

#### The pattern is not embroidered correctly.





Thread is twisted.	—
Thread tension is set incorrectly.	75

Symptom, Cause/solution	Reference
Fabric was not inserted into the frame correctly (fabric was loose, etc.).	54
Stabilizing material was not attached. <ul style="list-style-type: none"> <li>Always use stabilizing material, especially with stretch fabrics, lightweight fabrics, fabrics with a coarse weave, or fabrics that often cause pattern shrinkage. See your authorized Brother dealer for the proper stabilizer.</li> </ul>	53
There was an object placed near the machine, and the carriage or embroidery frame hit the object during embroidering.	31
Fabric outside the frame edges interferes with the arm, so the embroidery unit cannot move. <ul style="list-style-type: none"> <li>Reinsert the fabric in the embroidery frame so that the excess fabric is away from the arm, and rotate the pattern 180 degrees.</li> </ul>	54
Fabric is too heavy, so the embroidery unit cannot move freely. <ul style="list-style-type: none"> <li>Place a large thick book or similar object under the arm head to lightly lift the heavy side and keep it level.</li> </ul>	—
Fabric is hanging off the table. <ul style="list-style-type: none"> <li>If the fabric is hanging off the table during embroidery, the embroidery unit will not move freely. Place the fabric so that it does not hang off the table or hold the fabric to keep it from dragging.</li> </ul>	65
Fabric is snagged or caught on something. <ul style="list-style-type: none"> <li>Stop the machine and place the fabric so that it does not get caught or snagged.</li> </ul>	—
Embroidery frame was removed during embroidering (for example, to reset the bobbin). The presser foot was bumped or moved while removing or attaching the embroidery frame, or the embroidery unit was moved.	68
Stabilizer is incorrectly attached, for example, it is smaller than the embroidery frame.	53

<b>Loops appear on the surface of the fabric when embroidering</b>	
The thread tension is incorrectly set.	75
The tension of the upper thread is incorrectly set for the combination of the fabric, thread and pattern being used. <ul style="list-style-type: none"> <li>Use the embroidery needle plate cover.</li> </ul>	65
The combination of the bobbin case and bobbin thread is incorrect.	65

## ERROR MESSAGES

Below is an explanation of error messages. Refer to these when necessary (if you touch  or do the operation correctly while the error message is displayed, the message disappears).

	Error messages	Cause/solution
1	Cannot change the configuration of the characters.	This message is displayed when there are too many characters and the curved character configuration is impossible.
2	Cannot recognize the data for the selected pattern. The data may be corrupted.	This message is displayed when there is a possibility that the data for the selected pattern is corrupted.
3	Change to a larger embroidery frame.	This message is displayed when the machine is in embroidery mode and the small frame is attached, and the selected pattern does not fit in the small frame.
4	Failed to save file.	This message is displayed when no more images can be saved on the USB media. In this case, delete a file from the USB media or use different USB media.
5	Includes a special pattern that cannot be saved to external memory. Save the pattern in the machine's memory.	This message is displayed when you try to save a copyright protected pattern to USB media. According to copyright laws, patterns that are illegal to reproduce or edit cannot be saved to USB media. If this message displays, save the pattern in the machine's memory.
6	Lower the presser foot lever.	This message is displayed when  (Presser foot lifter button) is pressed while the presser foot lever is raised and the needle is lowered.
7	Not enough available memory to save the data. Delete some patterns or use a different media.	This message is displayed when the memory is full and the embroidery pattern cannot be saved.
8	OK to recall and resume previous memory?	This message appears if the machine is turned off while embroidering, then turned on again. Touch  to return the machine to the condition (pattern position and number of stitches) when it was turned off. Follow the procedure described in "If the Thread Breaks or the Bobbin Runs out of Thread During Embroidering" on page 68 to align the needle position and embroider the remainder of the pattern.
9	OK to separate the combined border pattern?	This message is displayed when rotating a saved combined pattern in the embroidery screen.
10	Pattern extends to the outside of embroidery frame.	This message is displayed when the machine is in embroidery mode, and the character pattern combination is too large to fit in the embroidery frame.
11	Pattern extends to the outside of embroidery frame. If you plan to add more patterns, rotate the pattern combination.	This message is displayed when the machine is in embroidery mode and the combined character pattern is too large for the embroidery frame. You can rotate the pattern 90 degrees and continue combining characters.
12	Preventive maintenance is recommended.	This message is displayed when the machine needs to be maintained. Once this message appears, it is recommended to take your machine to an authorized Brother dealer or the nearest Brother authorized service center for a regular maintenance check. Although this message will disappear and the machine will continue to function once you touch  , the message will display several more times until the appropriate maintenance is performed.
13	Set the clock.	This message appears when the time/date is not set. Set time/date. (page 11)
14	The bobbin thread is almost empty.	This message is displayed when the bobbin thread is running out. Although a few stitches can be embroidered when the "Start/Stop" button is pressed, replace with a wound bobbin immediately. When embroidering, touch  , touch  , remove the embroidery frame, and then replace the bobbin with one wound with plenty of embroidery bobbin thread. If [Upper and Bobbin Thread Sensor] in the general settings screen of the machine setting mode is set to [OFF], this message does not appear.
15	The bobbin winder safety device has activated. Is the thread tangled?	This message is displayed when the bobbin is being wound, and the motor locks because the thread is tangled, etc.



	Error messages	Cause/solution
16	The safety device was activated since the main shaft motor was heated. Is the thread tangled?	This message is displayed when the temperature of the motor increases, activating the safety device. Wait until the temperature decreases. If the error persists, contact your nearest authorized Brother dealer.
17	The safety device was activated since the main shaft motor seized. Is the thread tangled?	This message is displayed when the motor locks due to tangled thread or for other reasons related to thread delivery.
18	The safety device was activated since the needle position sensor malfunctioned.	This message is displayed when an error in the needle position sensor is detected, activating the safety device. Turn the machine off, then on again. If the message continues to appear, the machine may be damaged. Contact your nearest authorized Brother dealer.
19	There is no needle plate cover. Attach a needle plate cover.	This message is displayed when the needle plate cover is not attached.
20	This file cannot be used.	This message appears if the file format is incompatible with this machine. Check the list of compatible file formats. (page 119)
21	This file exceeds the data capacity and cannot be used. Use a suitable size file.	This message is displayed when the file size exceeds the data capacity of the machine. Confirm the file size and format. (page 119)
22	This USB media cannot be used.	This message is displayed when you try to use incompatible media. For a list of compatible USB media, visit <a href="https://s.brother/cpeag/">https://s.brother/cpeag/</a> .
23	USB media error	This message is displayed when an error occurs with the USB media. For a list of compatible USB media, visit <a href="https://s.brother/cpeag/">https://s.brother/cpeag/</a> .

## SPECIFICATIONS

Item	Specification		
Dimensions of machine	Approx. 612 mm (W) × 348 mm (H) × 321 mm (D) (approx. 24-3/32 inches (W) × 13-11/16 inches (H) × 12-5/8 inches (D))		
Weight of machine	Approx. 15 kg (approx. 33.1 lb)		
Dimensions of machine with embroidery unit attached	Approx. 916 mm (W) × 348 mm (H) × 524 mm (D) (approx. 36-1/16 inches (W) × 13-11/16 inches (H) × 20-5/8 inches (D))		
Weight of machine with embroidery unit attached	Approx. 20.7 kg (approx. 45.6 lb)		
Maximum embroidery speed	1050 stitches per minute		
Interfaces	Wireless LAN* <sup>1</sup>		
Memory	Embroidery patterns	10 MB	
	My Design Center	100 MB	
Data Types	Embroidery patterns* <sup>2</sup>	.pes .phc .phx .dst .pen	
	Data that can be loaded when using My Design Center	.jpg (up to 2 MB), .png (up to 2 MB), .bmp (up to 3 MB)	
Maximum embroidering area	360 mm (H) × 240 mm (W) (approx. 14 inches (H) × 9-1/2 inches (W))		
Types of USB Devices/Media that can be Used* <sup>3</sup>	Embroidery patterns	Data can be saved to or recalled from USB media. Use media that meets the following specifications. • USB Flash drive (USB Flash memory)  Embroidery data can be recalled only from; • USB External CD/DVD drives	
Condition of the [Eco Mode] and [Shutoff Support Mode]	[Eco Mode]	Available time	OFF, 10 - 120 (minute)
		“Start/Stop” button	Green flashing
		Suspended function	Machine light, Screen display, LED pointer
		After recovering	The machine starts from the previous operation.
	[Shutoff Support Mode]	Available time	OFF, 1 - 12 (hour)
		“Start/Stop” button	Green slow flashing
		Suspended function	All functions
		After recovering	An error message appears. You need to turn off and on the machine to restart.
Compatible image files of the Screen Saver Image	Format	.jpg	
	File size	Max. 150 KB for each image	
	File dimension	1280 × 1280 pixels or less (If the width is between 800 and 1279 pixels, the image will be displayed at 800 pixels.)	
	Number allowed	5 or less	
Videos that can be played	MP4 file format	Video - H.264/MPEG-4 AVC, Audio - AAC	
	Size	450 (H) × 800 (W)	
	Maximum file size	1 GB	

\*<sup>1</sup> The wireless network connection complies with IEEE 802.11b/g/n standards and uses the 2.4 GHz frequency. A wireless network cannot be set up with WPA™/WPA2™ Enterprise. Use Design Database Transfer or PE-DESIGN version 11 or later to transfer data from your computer to the machine. For the operating systems compatible with the software, visit our website <https://s.brother/cnekd/>.

\*<sup>2</sup> • Using data other than that saved using our data design systems or this machine may cause this machine to malfunction. When the machine is used to save a file with any extension, it is saved as a .phx data file.  
• Since Tajima (.dst) data does not contain specific thread color information, it is displayed with our default thread color sequence. Check the preview and change the thread colors as desired.

\*<sup>3</sup> Some USB media may not be usable with this machine. Please visit our website <https://s.brother/cpeag/> for more details.

\* Please be aware that some specifications may change without notice.

### Note

- We recommend using the 26 letters of the alphabet (uppercase and lowercase), the numbers 0 through 9, “-”, and “\_” for the name of the file/folder.

## IMPORTANT

- When using embroidery data other than our original patterns, the thread or needle may break when embroidering with a stitch density that is too fine or when embroidering three or more overlapping stitches. In that case, use one of our original data design systems to edit the embroidery data.

# UPDATING YOUR MACHINE'S SOFTWARE

You can update your machine's software using the following two procedures.

## Update Procedure Using USB Media

When an update program is available on <https://s.brother/cpage/>, please download the files following the instructions on the website and steps below.

### Note

- When using USB media to update the software, check that no data other than the update file is saved on the USB media being used before starting to update.

**1** While pressing  (Automatic threading button), turn the main power to ON.

**2** Touch .

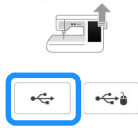

**3** Insert the USB media into the primary (top) USB port on the machine.

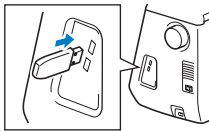

**4** Touch . → When updating is finished, the completion message appears.

**5** Turn the machine off, remove the USB media, and turn the machine on again.

## Update Procedure Using Wireless LAN Connection

If the machine is connected to a wireless network with a strong, reliable connection, update files can be downloaded directly to the machine using this network.

For details on the wireless LAN connection, refer to page 19.

### Memo

- The machine periodically checks if there is a new update file on the server. When there is a new update file, the wireless LAN key is displayed as .





**1** Display page 7 of the settings screen.

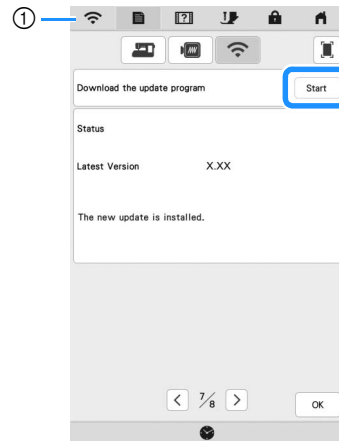

**2** Touch .

- \* The machine starts to download the update file, if there is a new update file on server.



- 1** When the wireless LAN key appears as , touching  causes the machine to check if there is a new update file. If there is a new file, downloading begins.

### Note

- Do not turn off the machine during the download.
- Touch  to pause the download. To restart, touch .

**3** When downloading is finished, turn off the machine, then hold down  (Automatic threading button) while turning on the machine.

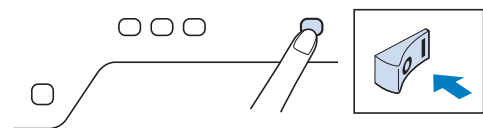

4 Touch .

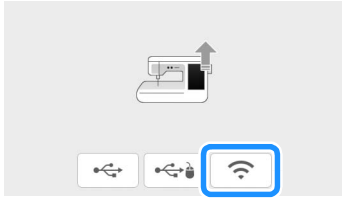

5 Touch  to update the machine.

\* Do not turn off the machine during the update.

 **Memo** \_\_\_\_\_

- If there are changes or additions to functions, manuals available on the machine may be updated.
-

## INDEX

## A

Air vent .....	9
Alphabet characters	
embroidery .....	35
Appliqué	
using an embroidery frame pattern .....	83
Automatic threading button .....	10, 26

## B

Bobbin	
setting .....	25
winding .....	22
Bobbin case	
cleaning .....	109
Bobbin cover .....	9
Bobbin threading	
setting the bobbin .....	25
winding the bobbin .....	22
Bobbin winder .....	9
Bobbin winding switch .....	23
Border key .....	42, 45

## C

Cleaning	
race .....	109
Clock .....	11
Color shuffling function .....	49
Couching patterns .....	84

## D

Decorative fill pattern .....	87
Deselect region setting .....	46

## E

Echo quilting .....	87
Eco mode .....	15
Editing	
embroidery edit .....	39
Embroidery	
2-point embroidery positioning function .....	61
adjusting the speed .....	78
automatic thread cutting function (End color trim) .....	77
key functions .....	52
resuming embroidery after turning off the power .....	69
selecting patterns .....	33
thread color display .....	79
thread trimming function (Jump stitch trim) .....	78
Embroidery appliqué .....	67
Embroidery edit	
changing the thread color .....	48
key functions .....	39
repeated patterns .....	42
Embroidery foot "W+" with LED pointer .....	111
Embroidery frames	
attaching .....	56
inserting fabric .....	54
removing .....	57
types .....	54
using the embroidery sheet .....	55
Embroidery needle plate cover .....	65
Embroidery patterns	
checking the position .....	60
editing .....	39
embroidering .....	65
linked characters .....	80
retrieving .....	82

saving .....	81
selecting .....	33
using a frame pattern to make an appliqué .....	83
Embroidery sheet .....	55
Embroidery unit .....	31
Error messages .....	117

## F

Favorite color scheme .....	50
-----------------------------	----

## H

Handle .....	9
Handwheel .....	9
Home page screen .....	12

## I

Image key .....	41
-----------------	----

## K

Key functions	
embroidery .....	52
embroidery edit .....	39

## L

LCD screen .....	9, 12
light .....	13

## M

Machine help key .....	17
Main power switch .....	9
Metallic thread .....	27
MPEG-4 (MP4) videos .....	18
My Design Center .....	89
My Design Snap App .....	107
My Stitch Monitor App .....	106

## N

Needle	
changing the needle .....	29
Needle bar thread guide .....	9
Needle plate .....	9
Needle position button .....	10

## O

Operation buttons .....	9, 10
-------------------------	-------

## P

Power cord .....	11
Power cord receptacle .....	9
Presser foot code .....	51
Presser foot lever .....	9
Presser foot lifter button .....	10
Presser foot/Needle exchange key .....	29, 111
Pretension disk .....	9, 23, 24

## R

Race .....	109
Repeated patterns .....	42
Retrieving	
embroidery patterns .....	82
machine's memory .....	82

**S**

---

Saving	
embroidery patterns .....	81
machine's memory .....	81
Screen saver .....	16
Screw for embroidery foot .....	9
Settings	
automatic thread cutting .....	77
embroidery settings .....	14
general settings .....	13
machine settings key .....	13
thread tension .....	75
thread trimming .....	78
Shutoff support mode .....	15
Speaker .....	13
Specifications .....	119
Spool cap .....	9
Spool net .....	27
Spool pin .....	9
Stabilizer .....	53
Start/Stop button .....	10
Starting point key .....	79
Stippling .....	87
Supplemental spool pin .....	9, 22

**T**

---

Thread	
thread tension .....	75
Thread color display .....	79
Thread color palette .....	48
Thread cutter .....	9
Thread cutter button .....	10
Thread guide .....	9, 23, 24
Thread guide plate .....	9, 24
Thread marks .....	45
Touch pen .....	112
Trial key .....	60
Troubleshooting .....	113
Tutorial video .....	17

**U**

---

Upgrading .....	121
Upper threading	
using the Automatic threading button .....	26
USB mouse .....	21
USB port .....	9













My Stitch Monitor is a mobile app that monitors the operating conditions of your machine.

Visit the Google Play™ or App Store to download.



Google Play™



App Store



My Design Snap is a mobile app that you can position your embroidery designs on the fabric, by capturing image of the hooped fabric and sending the image to your machine.

Visit the Google Play™ or App Store to download.



Google Play™



App Store



Design Database Transfer is a dedicated Windows application for wirelessly transferring embroidery data from a computer to the machine. This application can also be used to view and manage embroidery data.

Visit us at <https://s.brother/caeka/> to download the application.

Various optional accessories are available to be purchased separately.

Visit our website <https://s.brother/coeka/>.



Please visit us at <https://s.brother/cpeag/> where you can get product support and answers to frequently asked questions (FAQs).



Be sure to install the latest software.

A variety of functional improvements are being performed in the latest version.



Brother SupportCenter is a mobile app that provides the support information for your Brother product.

Visit the Google Play™ or App Store to download.



Google Play™



App Store

This machine is approved for use in the country of purchase only. Local Brother companies or their dealers will only support machines purchased in their own countries.

